

4 Push Button DALI Dimmer

- Standard DALI Master, control 4 DALI Addresses.
- Comply to latest DALI standard protocol IEC62386 and in compliance with DALI products from other international incorporation.
- Power is provided by DALI bus.
- 1-4 push button control.
- Enable to select 4 different addresses for controlling by encoding switch.
- Support scene, group, unicast and broadcast mode.
- Easy to be placed in standard wall junction box behind a push switch.

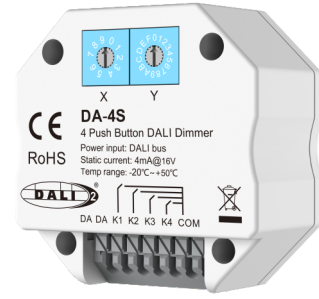

CE RoHS emc LVD RED

Technical Parameters

Input and Output		Environment		Package	
Input signal	4xpush switch signal	Operation temperature	Ta: -20°C ~ +50°C	Size	160 x W60 x H40mm
Output signal	DALI signal	Case temperature (Max.)	Tc: +55°C	Gross weight	0.046kg
Power supply	DALI bus	IP rating	IP20	Warranty	
Static current	4mA@16V			Warranty	5 years

Mechanical Structures and Installations

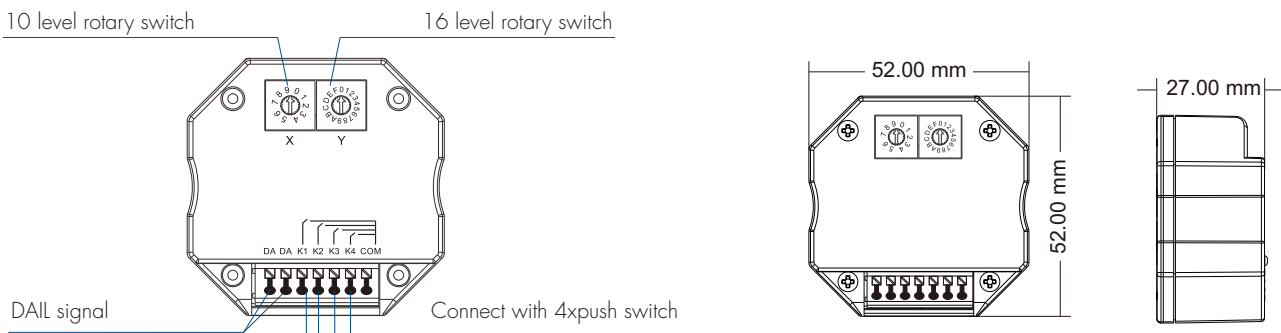

Wiring Diagram

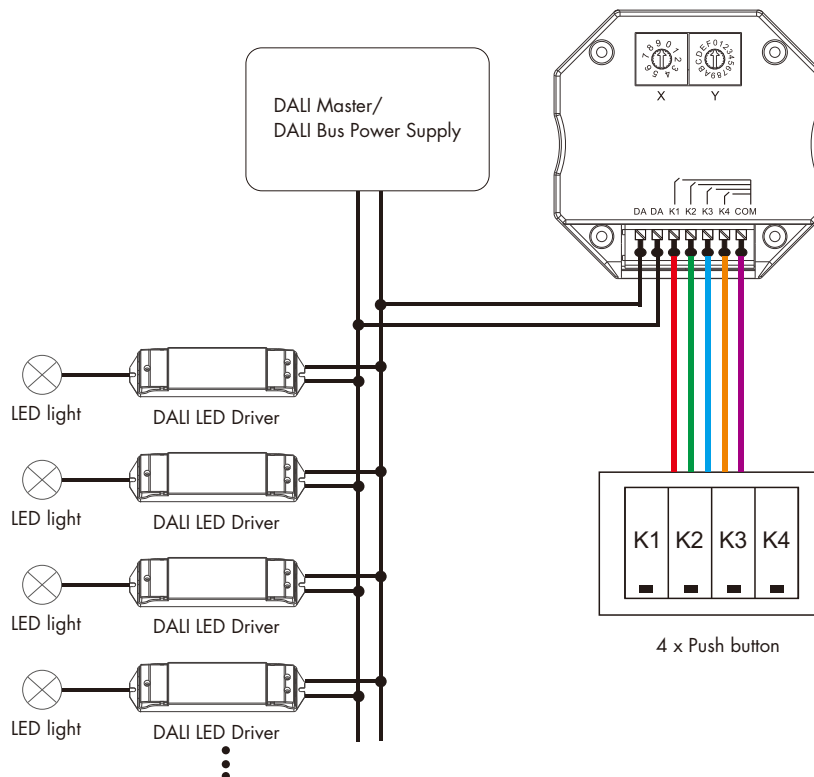

DALI address setting

Address value = $X * 10 + Y$.

For example: $X = 5, Y = 4$, Address value = $5 * 10 + 4 = 54$.

Unicast mode

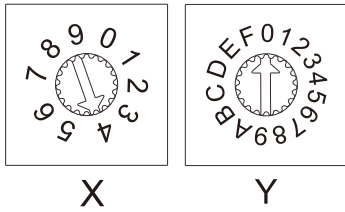

X is 0-6, Y is 0-9.

Address value 0-63 correspond to DALI unicast address 00-63.

For example:

Address value = 40, the unicast values of K1,K2,K3,K4 push button are 40, 41, 42, 43.

Address value = 62, the unicast values of K1,K2,K3,K4 push button are 62, 63, 0, 1.

Short press K1,K2,K3,K4 button to turn on/off light.

Long press K1,K2,K3,K4 button to increase or decrease brightness.

Group mode

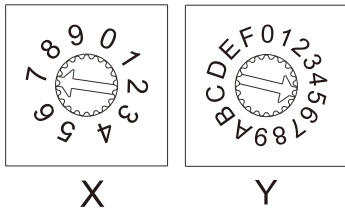

X is 7, Y is 0-F.

Address value 70-7F correspond to DALI group address 0-15.

For example:

Address value = 5, the group address value of K1,K2,K3,K4 push button are 5, 6, 7, 8.

Address value = E, the group address value of K1,K2,K3,K4 push button are 14, 15, 0, 1.

Short press K1,K2,K3,K4 button to turn on/off light.

Long press K1,K2,K3,K4 button to increase or decrease brightness.

Scene mode

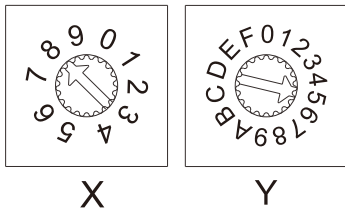

X is 8, Y is 0-F.

Address value 80-8F correspond to DALI scene 0-15.

For example:

Address value = 5, the scene value of K1,K2,K3,K4 push button are 5, 6, 7, 8.

Address value = E, the scene value of K1,K2,K3,K4 push button are 14, 15, 0, 1.

Short press K1,K2,K3,K4 button to recall the scene.

Long press K1,K2,K3,K4 button 2s to turn off the scene light.

Broadcast mode

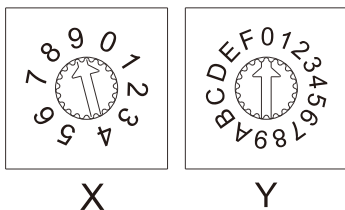

X is 9, Y is 0-F.

Address value 90 - 9F correspond to broadcast address.

Short press K1,K2,K3,K4 button to turn on/off light.

Long press K1,K2,K3,K4 button to increase or decrease brightness.