

**VLASTNOSTI**

- Výstup: 4 kanály
- BUS+SEQUENCER+FADER+DIMMER+DRIVER
- Vstup: DC 12/24/48 Vdc
- BUS príkaz: DMX512-A+RDM, DALI, MODBUS
- LOKÁLNE príkazy: 4x N.O. tlačidlo (s pamäťou alebo bez pamäte), 0-10 V, 1-10 V a potenciometer 10 kOhm
- Ovládacie prvky: Stmievateľ, Dim to Warm, Tunable White, RGB, RGBW
- Ovládacie výstupy a prúdové výstupy pre R-L-C zariadenia
- Typická účinnosť > 95 %
- Nastavenie jasu až po úplné vypnutie (stmievanie do tmy)
- Minimálna úroveň jasu: 0,1 % (1 % pri stlačení)
- Modulácia D-PWM
- Nastavenie frekvencie D-PWM: 300 / 600 / 1200 Hz
- Nastavenie výstupnej krivky: Lineárna / Kvadratická / Exponenciálna
- Mäkký štart a mäkké zastavenie
- Plynulá regulácia stmievania
- Funkcia Master / Slave (varianta DMX)
- Rozšírený teplotný rozsah
- 100 % funkčná skúška – 5-ročná záruka

→ Kompletný a aktualizovaný návod na použitie zariadenia nájdete na webovej stránke výrobcu: <http://www.dalcnet.com>

➤ **VARIANTY S KONŠTANTNÝM PRÚDOM (spoločná anóda)**

Použitie (4-kanálový výstup): Stmievateľ, Dim to warm, Tunable White, RGB, RGBW

KÓD	Napájacie napätie	Výstup	Kanály	Príkaz	
DLD1248-4CC-DMX	12–48 V DC	1x1000-2800 mA	4	DMX Tlačidlo N.O. / 0-10 / 1-10 / Pot 10kΩ	PROFESSIONAL
		4x250-700 mA			
DLD1248-4CC-MODBUS	12-48 V DC	1x1000-2800 mA	4	MODBUS RTU Tlačidlo N.O. / 0-10 / 1-10 / Pot 10kΩ	PROFESSIONAL
		4x250-700 mA			
DLD1248-4CC-DALI	12-48 V DC	1x1000-2800 mA	4	DALI N.O. tlačidlo / 0-10 / 1-10 / Pot 10kΩ	PROFESSIONAL
		4x250-700 mA			

➤ **VARIANTY S KONŠTANTNÝM NAPÄTÍM (spoločná anóda)**

Aplikácia (4-kanálový výstup): Stmievateľ, Dim to warm, Tunable White, RGB, RGBW

KÓD	Napájacie napätie	Výstup	Kanály	Príkaz	
DLD1248-4CV-DMX	12–48 V DC	1x20 A max	4	DMX Tlačidlo N.O. / 0-10 / 1-10 / Pot 10kΩ	PROFESSIONAL
		4x5A max			
DLD1248-4CV-MODBUS	12-48 V DC	1x20A max	4	MODBUS RTU Tlačidlo N.O. / 0-10 / 1-10 / Pot 10kΩ	PROFESSIONAL
		4x5A max			
DLD1248-4CV-DALI	12-48 V DC	1x20A max	4	DALI N.O. tlačidlo / 0-10 / 1-10 / Pot 10kΩ	PROFESSIONAL
		4x5A max			



➤ OCHRANY

		DLD1248-4CV	DLD1248-4CC
OTP	Ochrana proti prehriatiu ¹	✓	✓
OVP	Ochrana proti prepätiu ²	✓	✓
UVP	Ochrana proti podpätia ²	✓	✓
RVP	Ochrana proti prepólovaniu ²	✓	✓
IFP	Ochrana vstupnej poistky ²	✓	✓
SCP	Ochrana proti skratu	✓	✗
OCP	Ochrana proti otvorenému obvodu	✗	✓
CLP	Ochrana proti preťaženiu prúdom	✓	✓

➤ REFERENČNÉ NORMY

EN 61347-1	Ovládacie zariadenia svietidiel – Časť 1: Všeobecné a bezpečnostné požiadavky
EN 55015	Limity a metódy merania charakteristík rádiového rušenia elektrických osvetľovacích a podobných zariadení
EN	Zariadenia na všeobecné osvetlenie – Požiadavky na odolnosť proti elektromagnetickému rušeniu
EN	Technická dokumentácia na posudzovanie elektrických a elektronických výrobkov s ohľadom na obmedzenie nebezpečných látok
IEC/EN 62386-101	Digitálne adresovateľné rozhranie osvetlenia – Časť 101: Všeobecné požiadavky – Systém
IEC/EN 62386-102	Digitálne adresovateľné rozhranie osvetlenia – Časť 102: Všeobecné požiadavky – Ovládacie zariadenie
IEC/EN 62386-207	Digitálne adresovateľné rozhranie osvetlenia – Časť 207: Osobitné požiadavky na ovládacie zariadenia – LED moduly (typ zariadenia 6)
IEC 60929-E.2.1	Ovládacie rozhranie pre ovládateľné predradníky – ovládanie jednosmerným napätím – funkčná špecifikácia
ANSI E 1.3	Zábavná technika – Systémy riadenia osvetlenia – Špecifikácia analógového riadenia 0 až 10 V
ANSI E1.11	Zábavná technika – USITT DMX512-A – Asynchrónny sériový digitálny prenos dát pre ovládanie osvetľovacej techniky a príslušenstva
ANSI E1.20	Zábavná technika – RDM – Diaľkové riadenie zariadení cez siete USITT DMX512
-	ŠPECIFIKÁCIA APLIKÁCIE PROTOKOLU MODBUS V1.1b

¹ Tepelná ochrana na výstupnom kanáli v prípade vysokej teploty. Tepelná intervencia je detegovaná tranzistorom (>150 °C) alebo reguláciou prúdu (v závislosti od varianty zosilňovača).

² Iba ochrana riadiacej logiky



➤ TECHNICKÁ ŠPECIFIKÁCIA VÝSTUP S KONŠTANTNÝM NAPÄTÍM

		Variant Konštantné napätie	
Napájacie napätie		DC min: 10,8 Vdc .. max: 52,8 Vdc	
Výstupné napätie		= Vin	
Vstupný prúd		max 20 A	
Výstupný prúd ³		@ch	Celkom
		4x max. 5 A	// 1 x max. 20 A
Menovitý výkon ³	@12V	60 W/kanál	240 W celkom
	@24 V	120 W/kanál	480 W celkom
	@48 V	240 W/kanál	960 W celkom

➤ TECHNICKÁ ŠPECIFIKÁCIA VÝSTUP S KONŠTANTNÝM NAPÄTÍM

		Variant Konštantný prúd										
Napájacie napätie		DC min: 10,8 Vdc .. max: 52,8 Vdc										
Výstupné napätie		min: Vin/4 – max: Vin-0,9V										
Vstupný prúd		max 2,8 A										
Výstupný prúd ³		@ch					Celkom					
		4x max. 700 mA					// 1 x max. 2,8 A					
Menovitý výkon @ na kanál ³	Prúd [mA]	250	300	350	400	450	500	550	600	650	700	
	@12V	3	3,6 W	4,2 W	4,8 W	5,4 W	6 W	6,6 W	7,2 W	7,8 W	8,4 W	
	@24 V	6 W	7,2 W	8,4 W	9,6 W	10,8 W	12 W	13,2 W	14,4 W	15,6 W	16,8 W	
	@48 V	12 W	14,4 W	16,8 W	19,2 W	21,6 W	24 W	26,4 W	28,8 W	31,2 W	33,6 W	
Menovitý výkon ³	Prúd [mA]	250	300	350	400	450	500	550	600	650	700	
	@12V	12	14,4 W	16,8 W	19,2 W	21,6 W	24 W	26,4 W	28,8 W	31,2 W	33,6 W	
	@24 V	24 W	28,8 W	33,6 W	38,4 W	43,2 W	48 W	52,8 W	57,6 W	62,4 W	67,2 W	
	@48 V	48 W	57,6 W	67,2 W	76,8 W	86,4 W	96 W	105,6 W	115,2 W	124,8 W	134,4 W	

➤ TECHNICKÁ ŠPECIFIKÁCIA VÝSTUP S KONŠTANTNÝM NAPÄTÍM

Strata výkonu v pohotovostnom režime	<500 mW
Typ zaťaženia	R – L – C
Tepelné vyprnutie ⁴	150 °C
Frekvencia stmievania D-PWM	300 Hz – 600 Hz – 1200 Hz
Rozlíšenie D-PWM	16 bit
Rozsah D-PWM	0,1 % – 100
Skladovacia teplota	min: -40 max: +60 °C
Okolité teplota	min: -40 max: +60 °C
Zapojenie	Tlačidlá a zbernica: 1,5 mm ² pevný – 1 mm ² lankový – 30/14 AWG Napájanie a LED diódy: 2,5 mm ² pevný – 1,5 mm ² lankový – 30/12 AWG
Dĺžka prípravy vodiča	Tlačidlá a zbernica: 6 mm Napájanie a LED diódy: 7,5 mm
Stupeň ochrany	IP10
Materiál puzdra	Plast
Balenie (kusy/balenie)	Jednotlivá kartónová krabica – 1 ks Kartónová krabica 4 ks
Mechanické rozmery	72 x 92 x 62 mm – DIN RAIL 4mod.
Rozmery balenia	124 x 85 x 71 mm 263 x 178 x 82 mm
Hmotnosť	125 800 g

³ Maximálna hodnota, závislá od podmienok vetrania⁴ Tepelná ochrana na výstupnom kanáli v prípade vysokej teploty. Tepelná intervencia je detegovaná tranzistorom (>150 °C) alebo reguláciou prúdu (v závislosti od variantu zosilňovača).

➤ **INŠTALÁCIA**

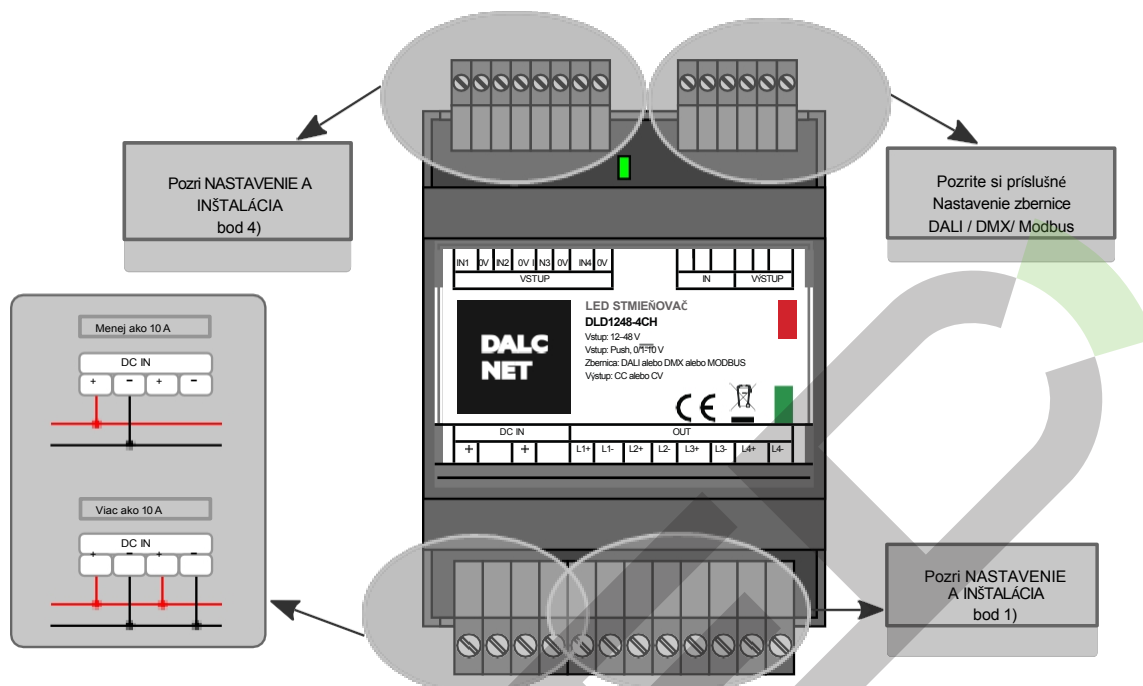

➤ **MECHANICKÉ ROZMERY:**
(bez konektorov)

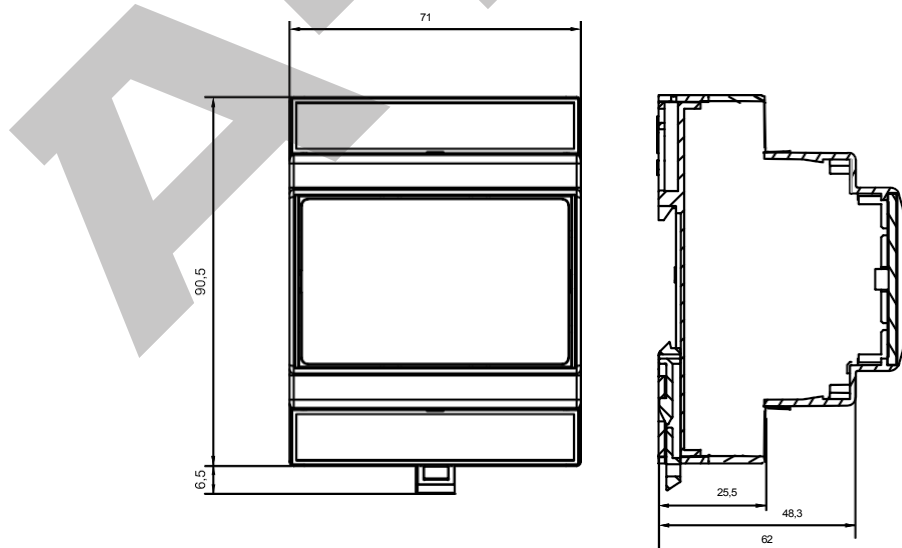

**➤ OTVORENIE KRYTU**

Pre konfiguráciu prepínačov Dip a voličov je potrebné zdvihnúť kryt zariadenia. Pozrite obrázok.

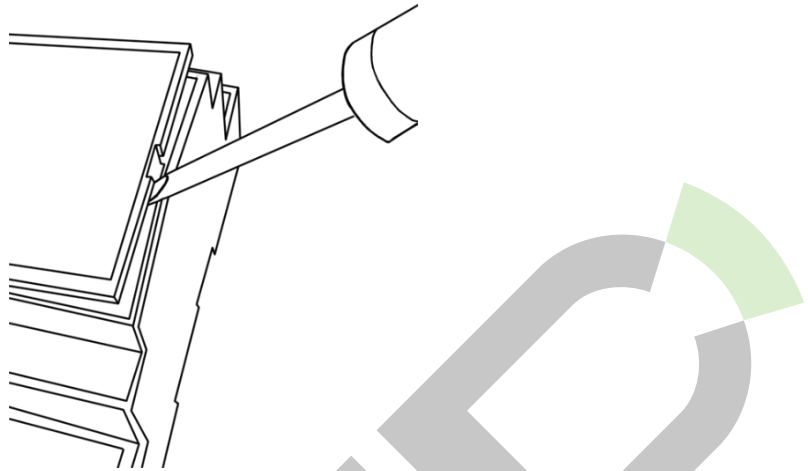
**➤ TECHNICKÉ POZNÁMKY****Inštalácia:**

- Inštaláciu a údržbu smie vykonávať iba kvalifikovaný personál v súlade s platnými predpismi.
- Produkt musí byť inštalovaný vo vnútri elektrického panela chráneného proti prepätiu.
- Produkt musí byť inštalovaný vo vertikálnej alebo horizontálnej polohe s krytom/etikou smerom nahor alebo vertikálne; iné polohy nie sú povolené. Nie je povolená poloha dnom nahor (s krytom/etikou smerom nadol).
- Oddelte obvody s napätím 230 V (LV) a obvody, ktoré nie sú SELV, od obvodov s nízkym napätím (SELV) a od akéhokoľvek pripojenia k tomuto produktu. Je absolútne zakázané pripájať z akéhokoľvek dôvodu priamo alebo nepriamo sieťové napätie 230 V k zbernici alebo iným častiam obvodu.

Napájanie:

- Na napájanie používajte iba napájacie zdroje SELV s obmedzeným prúdom, ochranou proti skratu a správne dimenzovaným výkonom. V prípade použitia napájacieho zdroja s uzemňovacími svorkami musia byť všetky body ochranného uzemnenia (PE = Protection Earth) pripojené k platnému a certifikovanému ochrannému uzemneniu.
- Pripojovacie káble medzi zdrojom napájania „nízkeho napätia“ a výrobkom musia byť správne dimenzované a mali by byť izolované od všetkých vodičov alebo častí s napätím, ktoré nie je SELV. Používajte káble s dvojito izoláciou.
- V prípade, že celkový výstupný prúd presahuje 10 A, zapojte oba páry napájacích vstupov „V+“ a „V-“.
- Dimenzujte napájanie pre zaťaženie pripojené k zariadeniu. Ak je napájanie predimenzované v porovnaní s maximálnym odoberaným prúdom, vložte medzi napájanie a zariadenie ochranu proti nadprúdu.
- Pre konštantný výstupný prúd musí byť napätie LED modulu (Vf) nižšie ako 5 V pri napätí napájacieho zdroja.

Príkaz:

- Dĺžka pripojovacích káblov medzi miestnymi ovládacími prvkami (tlačidlo N.O., 0-10 V, 1-10 V, potenciometer alebo iné) a výrobkom musí byť menšia ako 10 m; káble musia mať správne rozmery a mali by byť izolované od všetkých vodičov alebo častí s napätím, ktoré nie je SELV. Používajte dvojito izolované, tienené a skrútené káble.
- Dĺžka a typ pripojovacích káblov na zbernici (DMXS12, Modbus, DALI, Ethernet alebo iné) používajú káble podľa špecifikácie príslušných protokolov a predpisov a mali by byť izolované od každého vedenia alebo častí s napätím, ktoré nie je SELV. Odporúča sa používať dvojito izolované, tienené a skrútené káble.
- Všetky zariadenia s príslušným riadiacim signálom na zbernici (DMXS12, Modbus, DALI, Ethernet alebo iné) a na miestnom ovládaní (tlačidlo N.O., 0-10 V, 1-10 V, potenciometer alebo iné) musia byť SELV (pripojené zariadenia musia byť SELV alebo dodávať signál SELV).

Výstupy:

- Odporúča sa, aby dĺžka pripojovacích káblov medzi produktom a LED modulom bola menšia ako 10 m; káble musia mať správne rozmery a mali by byť izolované od všetkých vodičov alebo častí s napätím, ktoré nie je SELV. Odporúča sa používať dvojito izolované, tienené a skrútené káble. Ak chcete pripojiť produkt k LED modulom pomocou káblov dlhších ako 10 m, inštalátor musí zaručiť správne fungovanie systému. V žiadnom prípade neprekračujte dĺžku 30 m pripojenia medzi produktom a LED modulmi.

➤ **NASTAVENIE A INŠTALÁCIA**

12-polohový prepínač (pod krytom) ponúka širokú škálu možných konfigurácií:

Poznámka: Továrnske nastavenie = všetko vypnuté

Funkcia		<ul style="list-style-type: none"> • Prepínače z 1 na 2: • Prepínač 3: • Prepínače od 4 do 6: • Prepínače 7 až 8: • Prepínače z 9 na 10: • Prepínače od 11 do 12: 	<ul style="list-style-type: none"> • Typ zaťaženia • Paralelné výstupy • Mapa • Krivka • Typ vstupu • Výstupná snímková frekvencia (frekvencia) 																					
	<table border="1"> <tr> <td>1</td><td>2</td><td>3</td><td>4</td><td>5</td><td>6</td><td>7</td><td>8</td><td>9</td><td>10</td><td>11</td><td>12</td> </tr> <tr> <td>Carico</td><td>//</td><td>Mapa</td><td>Curva</td><td>Vstup</td><td>Hz</td><td></td><td></td><td></td><td></td><td></td><td></td> </tr> </table>			1	2	3	4	5	6	7	8	9	10	11	12	Carico	//	Mapa	Curva	Vstup	Hz			
1	2	3	4	5	6	7	8	9	10	11	12													
Carico	//	Mapa	Curva	Vstup	Hz																			

1) Vyberte typ zaťaženia a paralelný výstup v závislosti od výstupných pripojení: Prepínač z 1 na 2 a prepínač 3

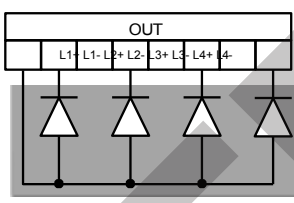
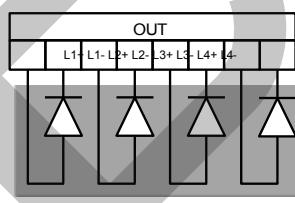
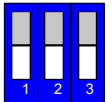
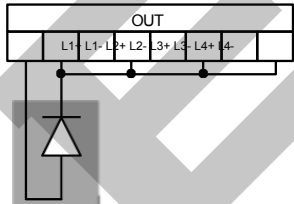
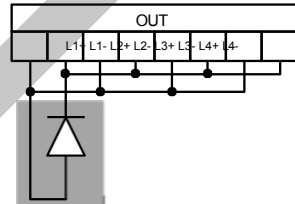
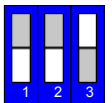
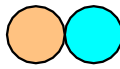
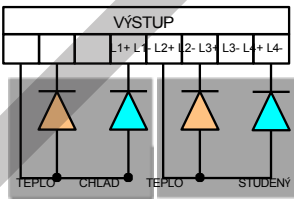
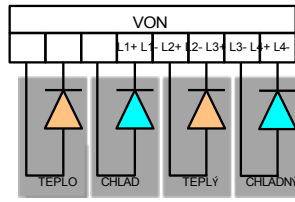
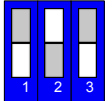
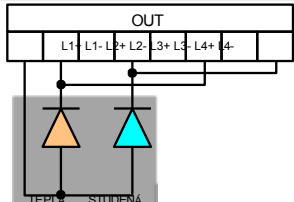
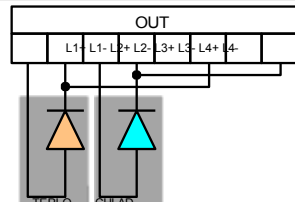
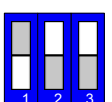
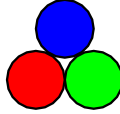
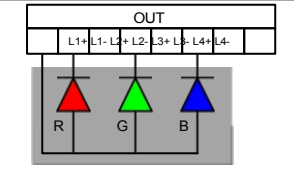
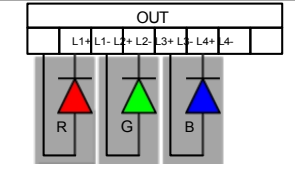
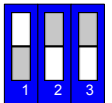
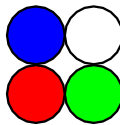
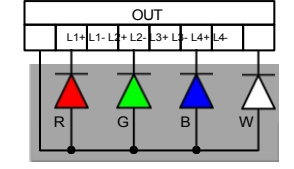
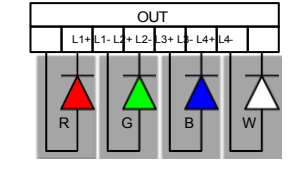
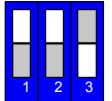
Typ zaťaženia	Popis	Pripojenia (Celkový prúd 0 – 10 A max.)	Pripojenia (Celkový prúd 0 – 20 A max.)	Nastavenia
	Biela, až 4 záťaže			
	Biele, paralelný výstupy so zvýšeným prúdom (makro stmievač)			
	Nastaviteľná biela, až 2 záťaže			
	Nastaviteľná biela, paralelné výstupné páry so zvýšeným prúdom			
	RGB			
	RGBW			

Poznámka: Nastavte „Vybrať mapu“ podľa pripojeného zaťaženia a požadovanej funkcie. Pozrite si „Nastavenie mapy“ na strane 7.



2) Vyberte mapu: Prepína z 4 na 6

Biele zaťaženie	Nastaviteľné biele zaťaženie	RGB zaťaženie	RGBW zaťaženie
Stmievateľ	Stmievateľ	Stmievateľ	Stmievateľ
	Stmievanie na teplú farbu	Stmievanie na teplú farbu	Stmievanie na teplú farbu
	Nastaviteľná biela	Nastaviteľná biela farba	Nastaviteľná biela
	Inteligentný HSV Intenzita, korekcia teploty, odtieň a rotácia farieb, sýtosť a stroboskop	Inteligentný HSV Intenzita, korekcia teploty, odtieň a rotácia farieb, sýtosť a stroboskop	Inteligentný HSV Intenzita, korekcia teploty, odtieň a rotácia farieb, sýtosť a stroboskop
	RGB	RGB Previesť RGB→RGBW	RGB Previesť RGB→RGBW
	RGBW Previesť RGBW→RGB	RGBW Previesť RGBW→RGB	RGBW Previesť RGBW→RGB
	Master+RGB+Strobe	Master+RGB+Strobe Previesť RGB→RGBW	Master+RGB+Strobe Previesť RGB→RGBW
	Master+RGBW+Strobe Previesť RGBW→RGB	Master+RGBW+Strobe	Master+RGBW+Strobe

3) Vyberte krivku stmievania: Prepína z 7 na 8

Predvolené (podľa typu zbernice)	Kvadratická	Exponenciálny	Lineárny

4) Vyberte typ lokálneho vstupu: Prepína z 9 na 10

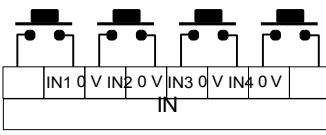
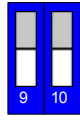
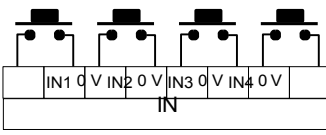
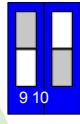
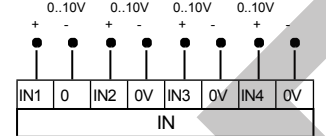
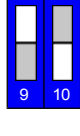
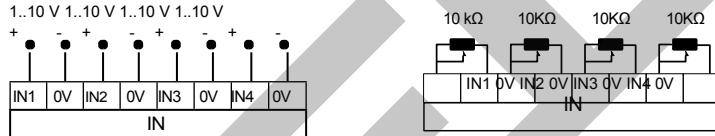
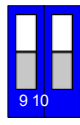
V type	Popis	Pripojenia	Nastavenie
Tlačidlo	N.O. Tlačidlo, bez pamäte		
	N.O. Tlačidlo, MEMORY		
0-10V	Analogové 0-10V		
1-10V	Analogový 1-10V a potenciometer		



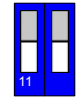
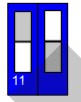
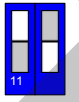
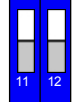

5) Nastavenie výstupnej frekvencie: Prepína z 11 na 12





300 Hz		600 Hz		1200 Hz		Vyhradené	
--------	---	--------	---	---------	---	-----------	--

➤ **REGULÁCIA VÝSTUPNÉHO PRÚDU**



































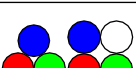

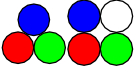

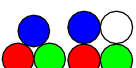











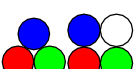



Implementácia funkcie len pre aktuálnu variantu: DLD1248-4CC-DMX; DLD1248-4CC-MODBUS; DLD1248-4CC-DALI.

Na nastavenie trimera je potrebné otvoriť predný panel zariadenia. Pozrite obrázok na strane 5.

	Nastavenie trimera	Aktuálna hodnota
Poloha 1		250 mA
Pozícia 2		300 mA
Poloha 3		350 mA
Poloha 4		400 mA
Poloha 5		450 mA

	Nastavenie trimera	Aktuálna hodnota
Poloha 6		500 mA
Pozícia 7		550 mA
Pozícia 8		600 mA
Pozícia 9		650 mA
Poloha 10		700 mA

➤ **FUNKČNOSŤ MIESTNYCH PRÍKAZOV PODĽA VYBRANEJ MAPY**

Typ zariadenia	Mapa	IN	IN 2	IN 3	IN 4
 Biela Až 4 náplne	Stmievač	Stmievač 1 	Stmievač 2 	Stmievač 3 	Stmievač 
 Biely Paralelné výstupy	Stmievač	Stmievač 			
 Nastaviteľná biela Až 2 zariadenia	Stmievač	Dim1 	Stmievač 		
 Nastaviteľná biela farba Paralelné výstupy	Stmievač	Stmievač 			
 Nastaviteľná biela farba Až 2 zariadenia	Stmieva nie na teplú farbu	Stmieva nie 1 na teplú farbu 	Stmieva nie 2 na teplú farbu 		
 Nastaviteľná biela farba Paralelné výstupy	Stmieva nie do teplej farby	Stmievač na teplú farbu 			
 Nastaviteľná biela Až 2 zariadenia	Nastaviteľ ná biela	Stmievanie 1 	CCT1 	Stmievanie 2 	CCT2 
 Nastaviteľná biela Paralelné výstupy	Nastaviteľ ná biela	Stmievač 	CCT 		
 RGB a RGBW	Stmievač	Stmievač 			
 RGB a RGBW	Stmieva nie na teplú farbu	Stmievač na teplú farbu 			
 RGB a RGBW	Nastaviteľ ná biela	Stmievač 	CCT 		
 RGB a RGBW	Intelige ntný HSV	Stmievač 	CCT 	Farba 	Sýtosť 
 RGB a RGBW	RGB	Červená 	Zelená 	Modrá 	
 RGB a RGBW	RGBW	Červená 	Zelená 	Modrá 	Biela 
 RGB a RGBW	MRGB+	Červená 	Zelená 	Modrá 	
 RGB a RGBW	MRGBW+	Červená 	Zelená 	Modrá 	Biela 



PRÍKLAD NASTAVENIA MAPY

Príkaz	Pripojenia	Nastavenia
Biele, až 4 zafáženia		
Skupinové ovládanie IN1 VSTUP: príkaz simultánneho riadenia výstupov L1 a L2 IN2 INPUT: príkaz simultánneho riadenia výstupov L3 a L4		
Nastaviteľná biela, až 2 zafáže		
RGB		
RGBW		



➤ MIESTNE VSTUPY

Dostupné funkcie: N.O. TLAČIDLO s pamäťou / N.O. TLAČIDLO bez pamäte:

	<p>Stmievateľ</p> <p>Stmievanie svetla podľa zvolenej stmievacej krivky pri zachovaní konštantnej farebnej teploty. Mäkké zapnutie s časom stmievania 200 ms, mäkké vypnutie s časom stmievania 1 s.</p> <p>Kliknutie: Zapnutie/vypnutie svetla. Dvojité kliknutie: Zapnutie svetla na 100 % Dlhé stlačenie (&gt;1 s) z polohy VYPNUTÉ: Zapnutie na 1 % (nočné režim) Dlhé stlačenie (&gt;1 s) z polohy ON: Stmievateľ HORE/DOLE</p>										
	<p>Stmievanie na teplú farbu</p> <p>Stmievanie svetla podľa zvolenej krivky stmievania. Farba teploty sa zvyšuje s intenzitou. Mäkké zapnutie s časom stmievania 200 ms, mäkké vypnutie s časom stmievania 1 s.</p> <p>Kliknutie: Zapnutie/vypnutie svetla. Dvojité kliknutie: Zapnutie svetla na 100 % Dlhé stlačenie (&gt;1 s) z vypnutého stavu: Zapnutie na 1 % (nočné režim) Dlhé stlačenie (&gt;1 s) z polohy zapnuté: Stmievanie nahor/nadol</p>										
	<p>CCT: Teplota korekcie farieb / Vyváženie bielej</p> <p>-Nastaviteľné biele zataženie: zmena farebnej teploty pri zachovaní konštantnej intenzity. Neutrálna biela je 50 % studená + 50 % teplá. -RGB záťaž: zmena ekvivalentnej farebnej teploty. Neutrálna biela má rovnakú hodnotu ako R, G, B. -RGBW záťaž: vyvažuje bielu farbu z bieleho výstupu na kompozitný RGB výstup. Neutrálna biela je 50 % biela + 50 % R+G+B.</p> <p>Dvojité kliknutie: Neutrálna biela Dlhé stlačenie (&gt;1s) z polohy VYPNUTÉ: Zmena farebnej teploty HORE/DOLE (studená ↔ teplá alebo biela ↔ R+G+B)</p>										
	<p>Rotácia a výber farieb</p> <p>Zmeňte farbu alebo rýchlosť rotácie farieb.</p> <p>Kliknutím: Štart/Stop rotácie farieb. Dvojité kliknutie: Zmeňte farbu (alebo rotáciu farieb) na bielu a naopak. Dlhé stlačenie (&gt;1 s) z polohy ON: Zmeňte rýchlosť rotácie, vybranú zo 4 preddefinovaných úrovní. Vybraná rýchlosť je vizualizovaná ako biele stroboskopické svetlo.</p> <table border="1"> <thead> <tr> <th>Rýchlosť otáčania</th> <th>Stroboskopický impulz</th> </tr> </thead> <tbody> <tr> <td>6 sekúnd</td> <td>10 bliknutí/sek.</td> </tr> <tr> <td>30 sekúnd</td> <td>5 bliknutí/sek.</td> </tr> <tr> <td>6 minút</td> <td>2 bliknutia/sek.</td> </tr> <tr> <td>30 minút</td> <td>1 bliknutie/sek.</td> </tr> </tbody> </table>	Rýchlosť otáčania	Stroboskopický impulz	6 sekúnd	10 bliknutí/sek.	30 sekúnd	5 bliknutí/sek.	6 minút	2 bliknutia/sek.	30 minút	1 bliknutie/sek.
Rýchlosť otáčania	Stroboskopický impulz										
6 sekúnd	10 bliknutí/sek.										
30 sekúnd	5 bliknutí/sek.										
6 minút	2 bliknutia/sek.										
30 minút	1 bliknutie/sek.										
	<p>Sýtosť farieb:</p> <p>Zmena sýtosti farieb: živé farby ↔ pastelové farby.</p> <p>Kliknutie: Prepínanie medzi bielou a farbami. Dvojité kliknutie: Maximálna sýtosť – živé farby. Dlhé stlačenie (&gt;1 s) z bielej: Minimálna sýtosť – pastelové farby. Dlhé stlačenie (&gt;1 s) z farby: Zmena hodnoty sýtosti.</p>										
	<p>Červená: lineárna zmena červeného kanála.</p> <p>Kliknutie: Zapnutie/vypnutie svetla. Dvojité kliknutie: Zapnite svetlo na 100 % Dlhé stlačenie (&gt;1 s) z polohy VYPNUTÉ: Zapnutie na 1 % Dlhé stlačenie (&gt;1 s) z polohy zapnuté: Stmievateľ nahor/nadol</p>										
	<p>Zelená: lineárna zmena zeleného kanála.</p> <p>Kliknutie: Zapnutie/vypnutie svetla. Dvojité kliknutie: Zapnutie osvetlenia na 100 % Dlhé stlačenie (&gt;1 s) z polohy VYPNUTÉ: Zapnutie na 1 % Dlhé stlačenie (&gt;1 s) z polohy ON: Stmievateľ HORE/DOLE</p>										
	<p>Modrá: lineárna zmena modrého kanála.</p> <p>Kliknutie: Zapnutie/vypnutie svetla. Dvojité kliknutie: Zapnutie osvetlenia na 100 % Dlhé stlačenie (&gt;1 s) z polohy VYPNUTÉ: Zapnutie na 1 % Dlhé stlačenie (&gt;1 s) z polohy zapnuté: Stmievateľ HORE/DOLE</p>										
	<p>Biela: lineárna zmena bieleho kanála.</p> <p>Kliknutie: Zapnutie/vypnutie svetla. Dvojité kliknutie: Zapnutie osvetlenia na 100 % Dlhé stlačenie (&gt;1 s) z polohy VYPNUTÉ: Zapnutie na 1 % Dlhé stlačenie (&gt;1 s) z polohy zapnuté: Stmievateľ nahor/nadol</p>										



Dostupné funkcie: 0-10 V / 1-10 V / potenciometer:

	<p>Stmievač Stmievajte svetlo podľa zvolenej stmievacej krivky a zachovajte konštantnú farebnú teplotu. Minimálna intenzita = 0,1 %</p> <p>Pod 1 V = Vypnite svetlo. 10 V = Maximálna intenzita</p>
	<p>Stmievanie na teplú farbu Stmievajte svetlo podľa zvolenej krivky stmievania. Farba teploty sa zvyšuje s intenzitou. Minimálna intenzita = 0,1 %</p> <p>Pod 1 V = Vypnite svetlo. 10 V = Maximálna intenzita</p>
	<p>CCT: Teplota farebnej korekcie / Vyváženie bielej</p> <p>-Nastaviteľné biele zaťaženie: zmena farebnej teploty pri zachovaní konštantnej intenzity. Neutrálna biela je 50 % studená + 50 % teplá. -RGB záťaž: zmena ekvivalentnej farebnej teploty. Neutrálna biela má rovnakú hodnotu ako R, G, B. -RGBW zaťaženie: vyvažuje bielu farbu z bieleho výstupu na kompozitný RGB výstup. Neutrálna biela je 50 % biela + 50 % R+G+B.</p> <p>Zmeňte farebnú teplotu z teplej (1 V) na studenú (10 V).</p>
	<p>Rotácia a výber farieb Zmeňte farbu.</p> <p>Vyberte farbu začínajúcu červenou (1V), potom žltou, zelenou, tyrkysovou, modrou, purpurovou a opäť červenou (10V).</p>
	<p>Sýtosť farieb: Zmeňte sýtosť farieb: živé farby ↔ pastelové farby Zmeňte sýtosť z bielej (1V) na živé farby (10V).</p>
	<p>Červená: lineárna zmena červeného kanála.</p> <p>Pod 1 V = Vypnite svetlo. 10 V = Maximálna intenzita</p>
	<p>Zelená: lineárna zmena zeleného kanála.</p> <p>Pod 1 V = Vypnite svetlo. 10 V = Maximálna intenzita</p>
	<p>Modrá: lineárna zmena modrého kanála.</p> <p>Pod 1 V = Vypnite svetlo. 10 V = Maximálna intenzita</p>
	<p>Biela: lineárna zmena bieleho kanála.</p> <p>Pod 1 V = Vypnúť svetlo. 10 V = Maximálna intenzita</p>

➤ **NASTAVENIE DALI BUS**

V **NASTAVENÍ DALI BUS** sú všetky LED diódy ovládané externým ovládačom DALI.

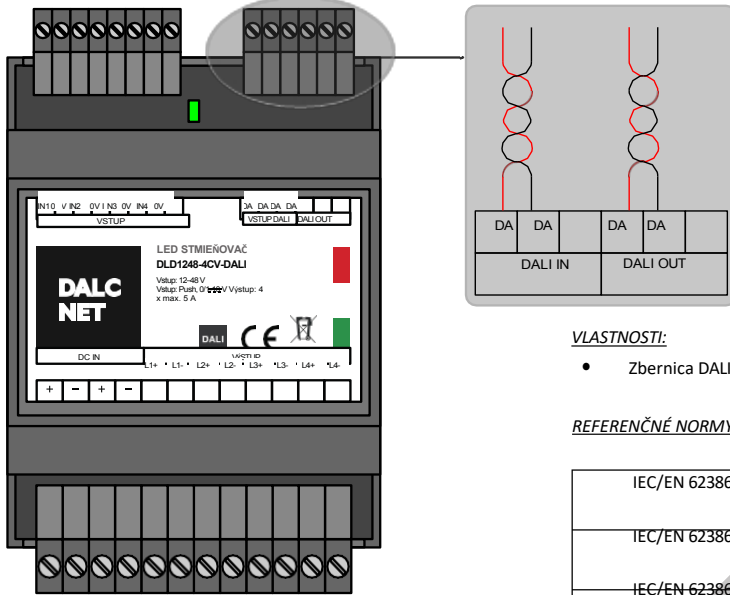

VLASTNOSTI:

- Zbernica DALI

REFERENČNÉ NORMY DALI BUS

IEC/EN 62386-101	Digitálne adresovateľné rozhranie osvetlenia – Časť 101: Všeobecné požiadavky – Systém
IEC/EN 62386-102	Digitálne adresovateľné rozhranie osvetlenia – Časť 102: Všeobecné požiadavky – Ovládacie zariadenie
IEC/EN 62386-207	Digitálne adresovateľné rozhranie osvetlenia – Časť 207: Osobitné požiadavky na riadiace zariadenia – LED moduly (typ zariadenia 6)

VSTAVANÉ LED:

V prípade, že nie je detegované napájanie zbernice alebo došlo k chybe zbernice, LED bliká rýchlo (2 impulzy za sekundu). V prípade, že je napájanie zbernice, ale nie sú k dispozícii žiadne dáta, LED bliká pomaly (1 impulz za sekundu).

V prípade aktívneho dátového prepojenia LED svietí nepretržite.

VZŤAH K MIESTNYM PRÍKAZOM:



Pri zapnutí, v prípade absencie pripojenia k zbernici, je aktívne lokálne ovládanie.

Keď je zistená zbernica, ovládanie prechádza na zbernicu. Zostáva na zbernici, kým nie je signál. Pri absencii signálu:

- ak je lokálny príkaz N.O. PUSH BUTTON, ovládanie prejde na lokálny príkaz v prípade stlačenia tlačidla N.O.
- ak je lokálny príkaz 0-10 V alebo 1-10 V, ovládanie prejde okamžite na lokálny príkaz.

ADRESOVANIE

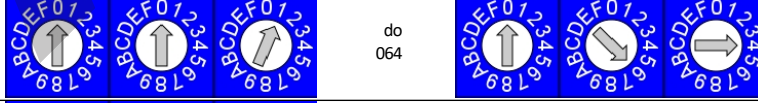
Pomocou voličov	✓
Zjednodušená metóda (pripojený je vždy jeden predradník)	✓
Náhodné pridelovanie adries	✓

DALI	000 (predvolené)		Adresa definovaná DALI
	od 001		Adresa prvého kanála, od 1 do 64
	FFF		(vyhradené)

➤ **MAPA KANÁLOV – DALI** Typ zaťaženia: Biela – až 4 zaťaženia

Adresa	Funkcia	Mapa: Stmievač
+0	Stmievač 1	Stmievač (hodnota jasu) 0 .. 254
+1	Stmievač 2	Stmievač (hodnota jasu) 0 .. 254
+2	Stmievač 3	Stmievač (hodnota jasu) 0 .. 254
+3	Stmievač 4	Stmievač (hodnota jasu) 0 .. 254

 Typ zaťaženia: Biela – Paralelné výstupy (makro stmievač)

Addr	Funkcia	Mapa: Stmievač
+0	Stmievač	Stmievač (hodnota jasu) 0 .. 254

 Typ zaťaženia: Nastaviteľná biela – až 2 zaťaženia

Addr	Funkcia	Mapa: Stmievač
+0	Stmievač 1	Stmievač (hodnota jasu) 0 .. 254
+1	Stmievač 2	Stmievač (hodnota jasu) 0 .. 254

Addr	Funkcia	Mapa: Stmievanie na teplé
+0	Stmievač 1	Stmievač (hodnota jasu) 0 .. 254
+1	Stmievač 2	Stmievač (hodnota jasu) 0 .. 254

Addr	Funkcia	Mapa: Nastaviteľná biela
+0	Stmievač 1	Stmievač (hodnota jasu) 0 .. 254
+1	Korekcia farieb 1	Teplota korekcie farieb 0 .. 254
+2	Stmievač 2	Stmievač (hodnota jasu) 0 .. 254
+3	Farba Korekcia 2	Teplota korekcie farieb 0 .. 254

 Typ zaťaženia: Nastaviteľná biela – Paralelné výstupy

Addr	Funkcia	Mapa: Stmievač
+0	Stmievač	Stmievač (hodnota jasu) 0 .. 254

Adresa	Funkcia	Mapa: Dim to Warm
+	Stmievač	Stmievač (hodnota jasu) 0 .. 254

Addr	Funkcia	Mapa: Nastaviteľná biela
+0	Stmievač	Stmievač (hodnota jasu) 0 .. 254
+1	Farba Korekcia	Teplota korekcie farieb 0 .. 254

DALC
NET

DLD1248 4 kanály

PRO

Návod k obsluhu zariadenia

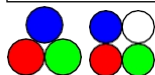
Vyrobené v
TalianskuRev. 2022-01-04
Strana 15 / 30

Typ zaťaženia: RGB a RGBW

Adresa	Funkcia	Mapa: Stmievač
+0	Hlavný Stmievač	Stmievač (hodnota jas) 0 .. 254

Addr	Funkcia	Mapa: Stmievanie na teplé
+	Hlavný Stmievač	Stmievač (hodnota jas) 0 .. 254

Addr	Funkcia	Mapa: Nastaviteľná biela
+0	Hlavný Stmievač	Stmievač (hodnota jas) 0 .. 254
+1	Farba Korekcia	Teplota korekcie farieb 0 .. 254

Adresa	Funkcia	Inteligentný HSV															
+0	Hlavný Stmievač	Stmievač (hodnota jas) 0 .. 254															
+1	Farba Korekcia	Teplota korekcie farieb 0 .. 254															
+2	Odtieň	Odtieň 0 .. 254															
+3	Rotácia odtieňa (duha) Čas	Jemné nastavenie odtieňa 0 ... 15	Podrž 16 ... 25	30 min 26 .. 51	15 min 52 .. 76	6 min 77 .. 102	3 min 103..127	1 min 128..153	30 s 154..179	15 s 180..204	6 s 205..230	3 s 231..254					
+4	Sýtosť	Sýtosť 0 .. 254															
+5	Stroboskop Rýchlosť	fix 0..15	blackout 16..31	1fps 32..47	2fps 48..63	3 fps 64..79	4 fps 80..95	5 fps 96..111	6 fps 112..127	7 fps 128..143	8 fps 144..159	9 fps 160..175	10 snímok za sekundu 176..191	12 fps 192..207	14 fps 208..223	16 fps 224..239	oprava 240..254

Adresa	Funkcia	Mapa: RGB
+	R	R 0 .. 254
+1	G	G 0 .. 254
+2	B	B 0 .. 254

Addr	Funkcia	Mapa: RGBW
+0	R	R .. 254
+1	G	G 0 .. 254
+2	B	B .. 254
+3	W	W 0 .. 254

Ad	Funkcia	Mapa: MRGB+															
+0	Hlavný Stmievač	Hlavný stmievač (hodnota jas) 0 .. 254															
+1	R	R 0 .. 254															
+2	G	G 0 .. 254															
+3	B	B 0 .. 254															
+4	Frekvencia stroboskopu	Fix	blackout	1 fps	2 fps	3 fps	4 fps	5 fps	6 fps	7 fps	8 fps	9 fps	10 fps	12 fps	14 fps	16 fps	oprava

Adresa	Funkcia	Mapa: MRGBW+
+0	Hlavný Stmievač	Hlavný stmievač (hodnota jas) 0 .. 254
+1	R	R .. 254
+2	G	G .. 254
+3	B	B .. 254

DALC NET	DLD1248 4 kanály																
	PRO																
Návod k obsluhu zariadenia														Vyrobené v Taliansku			
														Rev. 2022-01-04			
														Strana 16 / 30			
+4	W																
+5	Frekvencia stroboskopu	Fix	blackout	1fps	2fps	3 fps	4fps	5 fps	6 fps	7 fps	8 fps	9 fps	10 fps	12 fps	14 fps	16 fps	oprav a





➤ NASTAVENIE DMX+RDM BUS

Keď je **DMX+RDM BUS** v stave „slave“, výstupy sú riadené externým DMX ovládačom. V stave „master“ umožňujú DMX+RDM komunikáciu medzi zariadeniami.

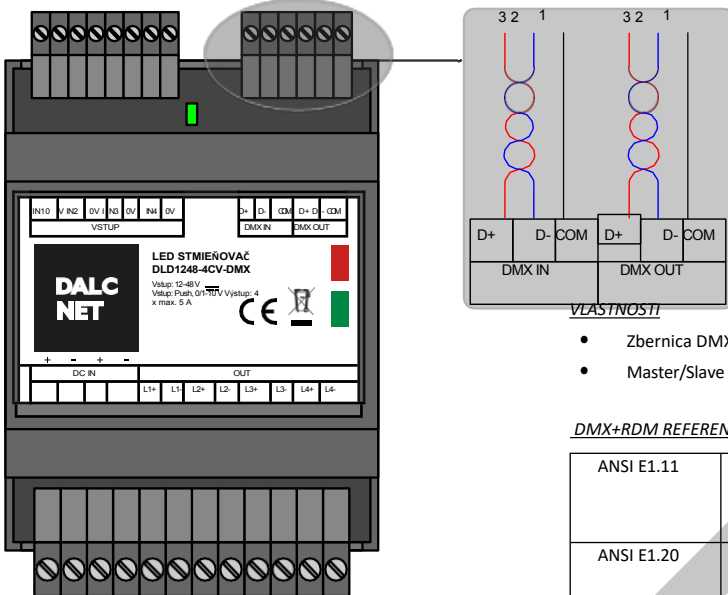

VLASTNOSTI

- Zbernica DMX512-A (NSC+RDM)
- Master/Slave

Použitie	3-pinový XLR Pin #	DMX512 Funkcia
Spoločná referenčná hodnota	1	Dátové prepojenie Spoločný
Primárne dátové prepojenie	2	Dáta 1-
	3	Dáta 1+
Sekundárne dátové prepojenie (voliteľné – pozri bod 4.8)	4	Dáta 2-
	5	Dáta 2+

DMX+RDM REFERENČNÉ ŠTANDARDY ZBERNICE

ANSI E1.11	Zábavná technika – USITT DMX512-A – Asynchrónny sériový digitálny prenos dát pre ovládanie osvetlenia Zariadenia a príslušenstvo
ANSI E1.20	Zábavná technika – RDM – Diaľkové riadenie zariadení prostredníctvom sietí USITT DMX512

TECHNICKÉ ŠPECIFIKÁCIE

Štandard DMX512-A/RDM

VSTAVANÁ LED:

V prípade chyby zbernice LED bliká rýchlo (2 impulzy za sekundu).

V prípade, že nie je detegovaná zbernica, LED bliká pomaly (1 impulz za sekundu). V prípade aktívneho dátového prepojenia LED svieti.

VZŤAH K MIESTNYM PRÍKAZOM:

Pri zapnutí, v prípade absencie pripojenia k zbernici, je aktívne lokálne ovládanie.

Keď je detegovaný BUS, ovládanie prechádza na BUS. Zostáva na BUS, kým nie je signál. Pri absencii signálu:

- ak je lokálny príkaz N.O. PUSH BUTTON, ovládanie prejde na lokálny príkaz v prípade stlačenia tlačidla N.O.
- ak je lokálny príkaz 0-10 V alebo 1-10 V, ovládanie prejde okamžite na lokálny príkaz.

ADRESOVANIE

RDM	✓
Pomocou voličov	✓

DMX	000 (Predvolené)			Adresovanie nastavené protokolom RDM	
	od 001		do 512		DMX adresovanie od 1 do 512
	F00				MASTER

➤ **MAPOVANIE KANÁLOV – DMX512** Typ zaťaženia: Biela – až 4 zaťaženia

Kanál	Funkcia	Mapa: Stmievač
1	Stmievač 1	Stmievač (hodnota jasu) 0 .. 255
2	Stmievač 2	Stmievač (hodnota jasu) 0 .. 255
3	Stmievač 3	Stmievač (hodnota jasu) 0 .. 255
4	Stmievač 4	Stmievač (hodnota jasu) 0 .. 255

 Typ zaťaženia: Biela – Paralelné výstupy (makro stmievač)

Kanál	Funkcia	Mapa: Stmievač
1	Stmievač	Stmievač (hodnota jasu) 0 .. 255

 Typ zaťaženia: Nastaviteľná biela – až 2 zaťaženia

Kanál	Funkcia	Mapa: Stmievač
1	Stmievač 1	Stmievač (hodnota jasu) 0 .. 255
2	Stmievač 2	Stmievač (hodnota jasu) 0 .. 255

Kanál	Funkcia	Mapa: Stmievanie na teplé
1	Stmievač 1	Stmievač (hodnota jasu) 0 .. 255
2	Stmievač 2	Stmievač (hodnota jasu) 0 .. 255

Kanál	Funkcia	Mapa: Nastaviteľná biela
1	Stmievač 1	Stmievač (hodnota jasu) 0 .. 255
2	Korekcia farieb 1	Teplota korekcie farieb 0 .. 255
3	Stmievač 2	Stmievač (hodnota jasu) 0 .. 255
4	Farba Korekcia 2	Teplota korekcie farieb 0 .. 255

 Typ zaťaženia: Nastaviteľná biela – Paralelné výstupy

Kanál	Funkcia	Mapa: Stmievač
1	Stmievač	Stmievač (hodnota jasu) 0 .. 255

Kanál	Funkcia	Mapa: Stmievanie na teplé
1	Stmievač	Stmievač (hodnota jasu) 0 .. 255

Kanál	Funkcia	Mapa: Nastaviteľná biela
1	Stmievač	Stmievač (hodnota jasu) 0 .. 255
2	Farba Korekcia	Teplota korekcie farieb 0 .. 255

DALC
NET

DLD1248 4 kanály

PRO

Návod k obsluhu zariadenia

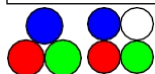
Vyrobené v
TalianskuRev. 2022-01-04
Strana 20 / 30

Typ zaťaženia: RGB a RGBW

Kanál	Funkcia	Mapa: Stmievač
1	Hlavný Stmievač	Stmievač (hodnota jas) 0 .. 255

Kanál	Funkcia	Mapa: Stmievanie na teplé
1	Master Stmievač	Stmievač (hodnota jas) 0 .. 255

Kanál	Funkcia	Mapa: Nastaviteľná biela
1	Hlavný Stmievač	Stmievač (hodnota jas) 0 .. 255
2	Farba Korekcia	Teplota korekcie farieb 0 .. 255

Kanál	Funkcia	Inteligentný HSV															
1	Hlavný Stmievač	Stmievač (hodnota jas) 0 .. 255															
2	Farba Korekcia	Teplota korekcie farieb 0 .. 255															
3	Odtieň	Odtieň 0 .. 255															
4	Rotácia odtieňa (duha) Čas	Jemné nastavenie odtieňa 0 ... 15	Podrž 16 ... 25	30 min 26 .. 51	15 min 52 .. 76	6 min 77 .. 102	3 min 103..127	1 min 128..153	30 s 154..179	15 s 180..204	6 s 205..230	3s 231..254					
5	Sýtosť	Sýtosť 0 .. 255															
6	Stroboskop Rýchlosť	fix 0..15	blackout 16..31	1fps 32..47	2fps 48..63	3 fps 64..79	4 fps 80..95	5 fps 96..111	6 fps 112..127	7 fps 128..143	8 fps 144..159	9 fps 160..175	10 fps 176..191	12 fps 192..207	14 fps 208..223	16 fps 224..239	oprava 240..254

Kanál	Funkcia	Mapa: RGB
1	R	R 0 .. 255
2	G	G 0 .. 255
3	B	B 0 .. 255

Kanál	Funkcia	Mapa: RGBW
1	R	R 0 .. 255
2	G	G 0 .. 255
3	B	B 0 .. 255
4	W	W 0 .. 255

Kan.	Funkcia	Mapa: MRGB+															
1	Hlavný Stmievač	Hlavný stmievač (hodnota jas) 0 .. 255															
2	R	R 0 .. 255															
3	G	G 0 .. 255															
4	B	B 0 .. 255															
5	Frekvencia stroboskopu	Fix	blackout	1fps	2 fps	3 fps	4fps	5 fps	6 fps	7 fps	8 fps	9 fps	10 fps	12 fps	14 fps	16 fps	oprava

Kanál	Funkcia	Mapa: MRGBW+															
1	Hlavný Stmievač	Hlavný stmievač (hodnota jas) 0 .. 255															
2	R	R 0 .. 255															
3	G	G 0 .. 255															
4	B	B 0 .. 255															
5	W	W 0 .. 255															
6	Frekvencia stroboskopu	Fix	blackout	1fps	2 fps	3 fps	4fps	5 fps	6 fps	7 fps	8 fps	9 fps	10 fps	12 fps	14 fps	16 snímok	oprava

➤ **RDM PRÍKAZY**

POŽADOVANÉ PARAMETRE	
DISC_UNIQUE_BRANCH	✓
DISC_UN_MUTE	✓
SUPPORTED_PARAMETERS	✓
PARAMETERS_DESCRIPTION	✓
INFORMÁCIE_O_ZARIADENÍ	✓
VERZIA_SOFTVÉRU_LABEL	✓
DMX_START_ADDRESS	✓
IDENTIFIKÁCIA_ZARIADENIA	✓

PODPOROVANÉ PARAMETRE	
ZOZNAM_ID_DETALOV_PRODUKTU	✓
POPIS_MODELU_ZARIADENIA	✓
VÝROBCA_LABEL	✓
DEVIDE_LABEL	✓
VERZIA_SOFTVÉRU_BOOT	✓
BOOT_SOFTWARE_VERSION_LABEL	✓
DMX_PERSONALITY	✓
DMX_PERSONALITY_DESCRIPTION	✓
SLOT_INFO	✓
SLOT_DESCRIPTION	✓
DEFAULT_SLOT_VALUE	✓



➤ DMX MASTER / SLAVE

Príklad pripojenia Master / Slave

Viac zariadení DLD1248-4CH-DMX je možné pripojiť podľa konfigurácie master/slave. Master a Slave musia mať rovnakú konfiguráciu DIP-SWITCH. Na výber požadovaného lokálneho príkazu je potrebné nastaviť DIP-SWITCH podľa pokynov v časti **Nastavenie DMX MASTER/SLAVE** na stranách 21 a 22.

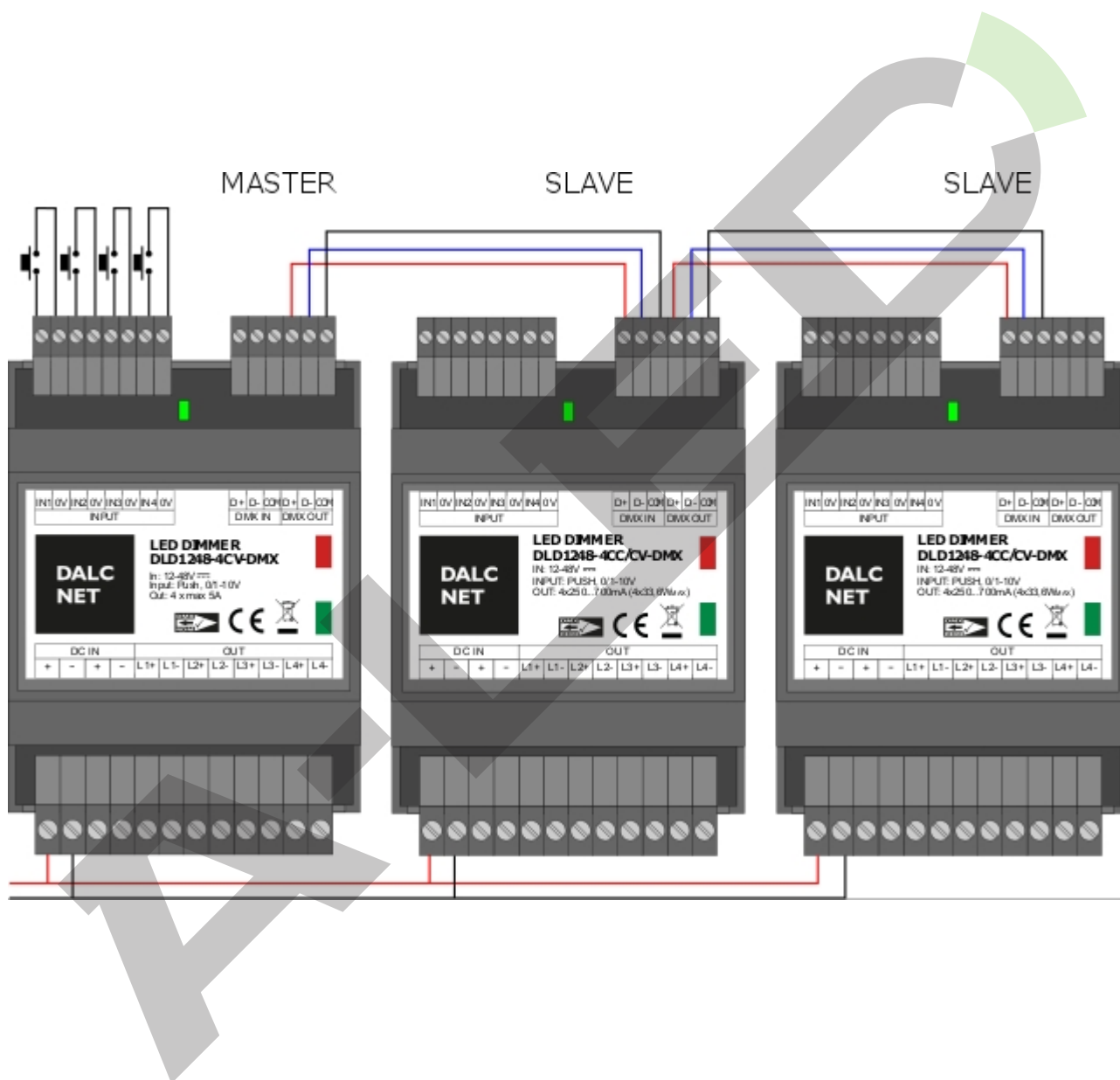

**DALC
NET**

DLD1248 4 kanály PRO

Návod k obsluhu zariadenia



Vyrobené v
Taliansku

Rev. 2022-01-04
Strana 24 / 30

➤ NASTAVENIE DMX Master/Slave

MASTER:

Poznámka: Master a Slave musia mať nastavenú rovnakú mapu (prepínače od 4 do 6).

Predvolený Master:

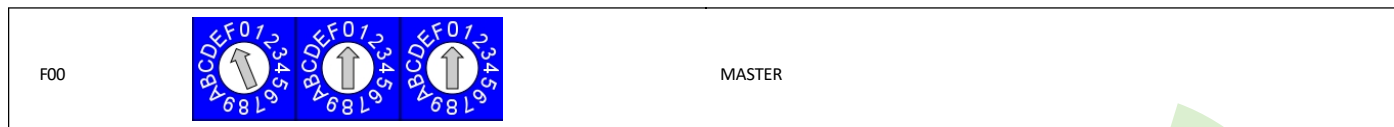

Hlavný s FADE UP / FADE DOWN:

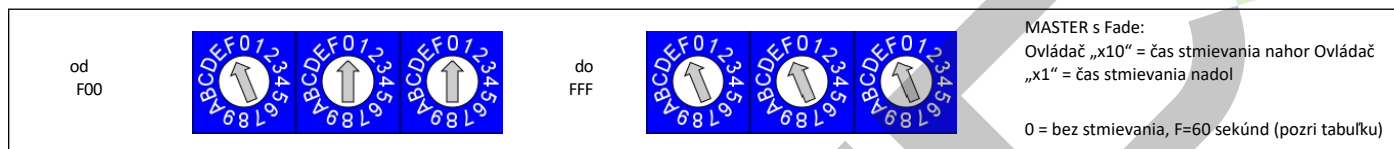

Časy stmievania:

0	1	2	3	4	5	6	7	8	9	A	B	C	D	E	F
NIE	0,5 s	1 s	2 s	3 s	4 s	5	6	7	8	9	10	15	20	30	60
fade															

Príklady:

Zapnutie/vypnutie bez stmievania (bez stmievania nahor/nadol): F00

Zapnutie bez stmievania (bez stmievania nahor) a vypnutie stmievania po 5 sekundách (stmievanie nadol): F06

Zapnutie stmievania po 1 sekunde (stmievanie nahor) a vypnutie stmievania po 10 sekundách (stmievanie nadol): F2B

Poznámky:

Táto funkcia je k dispozícii na mapách: „Stmievač“, „Stmievať na teplú farbu“, „Nastaviteľná biela“, „Inteligentné farby“

Slaves sledujú rampy master fade.



DLD1248 4 kanály PRO Návod k obsluhu zariadenia



Vyrobené v
Taliansku

Rev. 2022-01-04
Strana 25 / 30

SLAVE:

Poznámka: Hlavný a podriadený musia mať nastavenú rovnakú mapu (prepínače od 4 do 6).

Predvolený Slave:

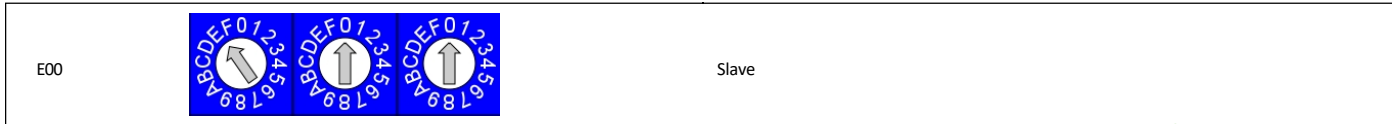

Slave: Efekt farebnej vlny (len v mape „Smart HSV“):

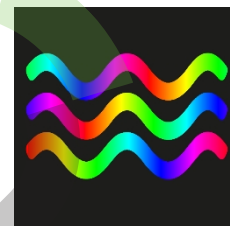

Easy vytvára efekt „farebnej vlny“ a pridáva oneskorenie od synchronizácie fázy master. Oneskorenie sa volí na každom slave v krokoch po 15°, od 0° (E00) do 345° (E23).

Slave, efekt farebnej vlny:
 00 = synchronizácia s masterom (bez vlny)
 01 = 15° fáza
 ...
 08 = fáza 120
 ...
 16 = fáza 240
 ...
 23 = 345° fáza

Fázové oneskorenia:

E00	E01	E02	E03	E04	E05	E06	E07	E08	E09	E10	E11
0	15	30	45	60	75	90	105	120	135	150	165
E12	E13	E14	E15	E16	E17	E18	E19	E20	E21	E22	E23
180	195	210	225	240	255	270	285	300	315	330	345

Príklady:

E00 0° Synchronizácia s hlavným zariadením	E04 60° fázové oneskorenie	E08 120° fázové oneskorenie R→B, G→R, B→G	E12 180° fázové oneskorenie Komplementárna farba	E16 240° fázové oneskorenie R→G, G→B, B→R	E20 300° fázové oneskorenie



➤ **NASTAVENIE MODBUS**

V **nastavení MODBUS** v stave „slave“ sú výstupné LED diódy riadené externým hlavným ovládačom MODBUS RTU (RS-485).

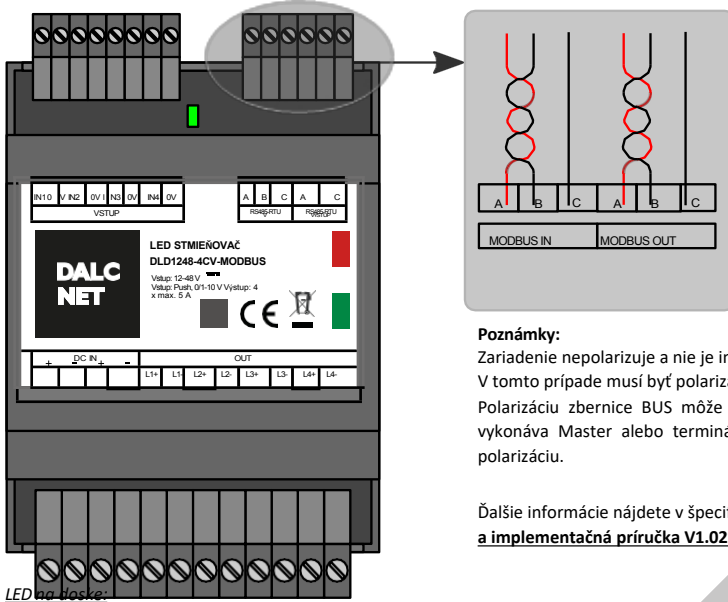

VLASTNOSTI

- BUS MODBUS RTU SLAVE na RS485

MODBUS REFERENČNÉ NORMY

- ŠPECIFIKÁCIA APLIKÁCIE MODBUS V1.1b

Poznámky:

Zariadenie nepolarizuje a nie je implementovaná schopnosť polarizovať BUS.

V tomto prípade musí byť polarizácia zbernice implementovaná externe.

Polarizáciu zbernice BUS môže vykonávať Master Modbus alebo terminály zariadenia. Ak polarizáciu zbernice BUS vykonáva Master alebo terminál zariadenia, žiadne zariadenie prítomné na zbernici BUS nesmie vykonávať žiadnu polarizáciu.

Ďalšie informácie nájdete v špecifikácii MODBUS „[Špecifikácia MODBUS cez sériovú linku a implementačná príručka V1.02](#)“.

LED na boku:

V prípade chyby zbernice LED bliká rýchlo (2 impulzy za sekundu).

V prípade, že nie je detegovaná zbernica, LED bliká pomaly (1 impulz za sekundu). V prípade aktívneho dátového prepojenia LED svieti.

VZŤAH K MIESTNYM PŘÍKAZOM

- **MIESTNE OVLÁDANIE NASTAVENÉ AKO TLAČIDLO N.O.:**
Lokálny príkaz je vždy aktívny, aj keď je prítomná zbernica. Ak použivate lokálny príkaz, dostupné premenné sa aktualizujú v režime čítania/zapisovania do zbernice. Ak naopak používate zbernicu, aktualizuje sa stav lokálneho príkazu.
Toto nastavenie vám umožňuje ovládať stav výstupu, či už ide o lokálny príkaz alebo zbernicu, súčasne. Lokálny príkaz má vždy prednosť pred príkazom zbernice. Stav zariadenia je viditeľný zo zbernice a je možné ho zobraziť prostredníctvom dohľadového systému.
- **MIESTNE PŘÍKAZY NASTAVENÉ AKO 0..10 V, 1..10 V ALEBO POTENCIOMETER**
Pri zapnutí, v prípade absencie pripojenia k zbernici, je aktívne lokálne ovládanie.
Keď je zistená prítomnosť zbernice, ovládanie prechádza na zbernicu. Zostáva na zbernici, kým je prítomný signál. Ak signál chýba, ovládanie okamžite prechádza na lokálny príkaz.

ADRESOVANIE SELEKTORMI

Selektory x10, x1 (stredný a pravý)			
Modbus	00 (predvolené)		Predvolené modbus ID (1)
	od 01		do 99

Selektor x100 (vľavo)							
Modbus							
	0	1	2	3	4	5	6
	115200 baudov	115200 baudov	38400 baud	38400 baud	19200 baud	19200 baud	9600 baudov
	8N1	8E1	8N1	8E1	8N1	8E1	8N1

➤ **MAPA KANÁLOV – MODBUS**

○ Typ zaťaženia: Biela – až 4 zaťaženia

Var	Funkcia	Mapa: Stmievač
0	Stmievač 1	Stmievač (hodnota jasu) 0 .. 255
1	Stmievač 2	Stmievač (hodnota jasu) 0 .. 255
2	Stmievač 3	Stmievač (hodnota jasu) 0 .. 255
3	Stmievač 4	Stmievač (hodnota jasu) 0 .. 255

○ Typ zaťaženia: Biela – Paralelné výstupy (makro stmievač)

Var	Funkcia	Mapa: Stmievač
0	Stmievač	Stmievač (hodnota jasu) 0 .. 255

●● Typ zaťaženia: Nastaviteľná biela – až 2 zaťaženia

Var	Funkcia	Mapa: Stmievač
0	Stmievač 1	Stmievač (hodnota jasu) 0 .. 255
1	Stmievač 2	Stmievač (hodnota jasu) 0 .. 255

Var	Funkcia	Mapa: Stmievanie na teplé
0	Stmievač 1	Stmievač (hodnota jasu) 0 .. 255
1	Stmievač 2	Stmievač (hodnota jasu) 0 .. 255

Var	Funkcia	Mapa: Nastaviteľná biela
0	Stmievač 1	Stmievač (hodnota jasu) 0 .. 255
1	Korekcia farieb 1	Teplota korekcie farieb 0 .. 255
2	Stmievač 2	Stmievač (hodnota jasu) 0 .. 255
3	Farba Korekcia 2	Teplota korekcie farieb 0 .. 255

●● Typ zaťaženia: Nastaviteľná biela – Paralelné výstupy

Var	Funkcia	Mapa: Stmievač
0	Stmievač	Stmievač (hodnota jasu) 0 .. 255

Var	Funkcia	Mapa: Stmievanie na teplé
0	Stmievač	Stmievač (hodnota jasu) 0 .. 255

Var	Funkcia	Mapa: Nastaviteľná biela
0	Stmievač	Stmievač (hodnota jasu) 0 .. 255
1	Farba Korekcia	Teplota korekcie farieb 0 .. 255

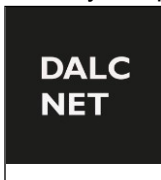

DLD1248 4 kanály PRO

Návod k obsluhu zariadenia



Vyrobené v
Taliansku

Rev. 2022-01-04
Strana 28 / 30

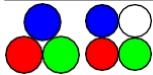

Typ zaťaženia: RGB a RGBW

Var	Funkcia	Mapa: Stmieváč
0	Hlavný Stmieváč	Stmieváč (hodnota jas) 0 .. 255

Var	Funkcia	Mapa: Stmievanie na teplé
0	Master Stmieváč	Stmieváč (hodnota jas) 0 .. 255

Var	Funkcia	Mapa: Nastaviteľná biela
0	Hlavný Stmieváč	Stmieváč (hodnota jas) 0 .. 255
1	Farba Korekcia	Korekcia farebnej teploty 0 .. 255

Var	Funkcia	Inteligentný HSV																
0	Hlavný Stmieváč	Stmieváč (hodnota jas) 0 .. 255																
1	Farba Korekcia	Korekcia farebnej teploty 0 .. 255																
2	Odtieň	Odtieň 0 .. 255																
3	Rotácia odtieňa (duha) Čas	<table border="1" style="font-size: small;"> <tr> <td>Jemné nastavenie odtieňa 0 ... 15</td> <td>Podrž 16 ... 25</td> <td>30 min 26 .. 51</td> <td>15 min 52 .. 76</td> <td>6 min 77 .. 102</td> <td>3 min 103..127</td> <td>1 min 128..153</td> <td>30 s 154..179</td> <td>15 s 180..204</td> <td>6s 205..230</td> <td>3s 231..254</td> </tr> </table>	Jemné nastavenie odtieňa 0 ... 15	Podrž 16 ... 25	30 min 26 .. 51	15 min 52 .. 76	6 min 77 .. 102	3 min 103..127	1 min 128..153	30 s 154..179	15 s 180..204	6s 205..230	3s 231..254					
Jemné nastavenie odtieňa 0 ... 15	Podrž 16 ... 25	30 min 26 .. 51	15 min 52 .. 76	6 min 77 .. 102	3 min 103..127	1 min 128..153	30 s 154..179	15 s 180..204	6s 205..230	3s 231..254								
4	Sýtosť	Sýtosť 0 .. 255																
5	Stroboskop Rýchlosť	<table border="1" style="font-size: small;"> <tr> <td>fixná 0..15</td> <td>blackout 16..31</td> <td>1fps 32..47</td> <td>2fps 48..63</td> <td>3fps 64..79</td> <td>4 fps 80..95</td> <td>5 fps 96..111</td> <td>6 fps 112..127</td> <td>7 fps 128..143</td> <td>8 fps 144..159</td> <td>9 fps 160..175</td> <td>10 fps 176..191</td> <td>12 fps 192..207</td> <td>14 fps 208..223</td> <td>16 fps 224..239</td> <td>oprava 240..254</td> </tr> </table>	fixná 0..15	blackout 16..31	1fps 32..47	2fps 48..63	3fps 64..79	4 fps 80..95	5 fps 96..111	6 fps 112..127	7 fps 128..143	8 fps 144..159	9 fps 160..175	10 fps 176..191	12 fps 192..207	14 fps 208..223	16 fps 224..239	oprava 240..254
fixná 0..15	blackout 16..31	1fps 32..47	2fps 48..63	3fps 64..79	4 fps 80..95	5 fps 96..111	6 fps 112..127	7 fps 128..143	8 fps 144..159	9 fps 160..175	10 fps 176..191	12 fps 192..207	14 fps 208..223	16 fps 224..239	oprava 240..254			

Var	Funkcia	Mapa: RGB
0	R	R 0 .. 255
1	G	G 0 .. 255
2	B	B 0 .. 255

Var	Funkcia	Mapa: RGBW
0	R	R .. 255
1	G	G 0 .. 255
2	B	B .. 255
3	W	W 0 .. 255

Var	Funkcia	Mapa: MRGB+																
0	Hlavný Stmieváč	Hlavný stmieváč (hodnota jas) 0 .. 255																
1	R	R 0 .. 255																
2	G	G 0 .. 255																
3	B	B 0 .. 255																
4	Frekvencia stroboskopu	<table border="1" style="font-size: small;"> <tr> <td>Fix</td> <td>blackout</td> <td>1fps</td> <td>2 fps</td> <td>3 fps</td> <td>4fps</td> <td>5 fps</td> <td>6 fps</td> <td>7 fps</td> <td>8 fps</td> <td>9 fps</td> <td>10 fps</td> <td>12 fps</td> <td>14 fps</td> <td>16 fps</td> <td>oprava</td> </tr> </table>	Fix	blackout	1fps	2 fps	3 fps	4fps	5 fps	6 fps	7 fps	8 fps	9 fps	10 fps	12 fps	14 fps	16 fps	oprava
Fix	blackout	1fps	2 fps	3 fps	4fps	5 fps	6 fps	7 fps	8 fps	9 fps	10 fps	12 fps	14 fps	16 fps	oprava			

Var	Funkcia	Mapa: MRGBW+																
0	Hlavný Stmieváč	Hlavný stmieváč (hodnota jas) 0 .. 255																
1	R	R .. 255																
2	G	G .. 255																
3	B	B .. 255																
4	W	W 0 .. 255																
5	Frekvencia stroboskopu	<table border="1" style="font-size: small;"> <tr> <td>Fix</td> <td>blackout</td> <td>1fps</td> <td>2 fps</td> <td>3 fps</td> <td>4fps</td> <td>5 fps</td> <td>6 fps</td> <td>7 fps</td> <td>8 fps</td> <td>9 fps</td> <td>10 fps</td> <td>12 fps</td> <td>14 fps</td> <td>16 snímok</td> <td>oprava</td> </tr> </table>	Fix	blackout	1fps	2 fps	3 fps	4fps	5 fps	6 fps	7 fps	8 fps	9 fps	10 fps	12 fps	14 fps	16 snímok	oprava
Fix	blackout	1fps	2 fps	3 fps	4fps	5 fps	6 fps	7 fps	8 fps	9 fps	10 fps	12 fps	14 fps	16 snímok	oprava			

➤ **PODPOROVANÉ FUNKCIE PRE ČÍTANIE A ZÁPIS – MODBUS RTU**

Funkčný kód		
0x01	Čítanie cievok	✘
0x02	Čítanie diskretných vstupov	✘
0x03	Čítanie registrov držania	✔
0x04	Čítanie vstupného registra	✘
0x05	Zapisovanie jednej cievky	✘
0x06	Zapisovanie jedného registra	✔
0x07	Čítanie stavu výnimky	✘
0x08	Diagnostika	✘
0x0B	Získať počítadlo udalostí Co	✘
0x0C	Získať protokol udalostí Com	✘
0x0F	Zapísať viacero cievok	✘
0x10	Zapisovať viacero registrov	✔
0x11	Oznámiť ID servera	✘
0x14	Čítanie záznamu súboru	✘
0x15	Zapisovanie záznamu súboru	✘
0x16	Zapisovanie masky registra	✘
0x17	Čítanie/zapisovanie viacerých registrov	✘
0x18	Čítanie fronty FIFO	✘
0x2B	Čítanie identifikácie zariadenia	✘

**FEATURES**

- Output: 4 channels
- BUS+SEQUENCER+FADER+DIMMER+DRIVER
- Input: DC 12/24/48 Vdc
- BUS Command: DMX512-A+RDM, DALI, MODBUS
- LOCAL Command: 4x N.O. push button (with or without memory), 0-10V, 1-10V and Potentiometer 10KOhm
- Controls: Dimmer, Dim to Warm, Tunable White, RGB, RGBW
- Control outputs and Current outputs for R-L-C loads
- Typical efficiency > 95%
- Adjusting the brightness up to completed off (Dim to Dark)
- Level minimum of brightness: 0.1% (1% in push)
- D-PWM Modulation
- Adjusting D-PWM frequency: 300 / 600 / 1200 Hz
- Adjusting output curve: Linear / Quadratic / Exponential
- Soft start and soft stop
- Soft dimming regulation
- Master / Slave Function (DMX variant)
- Extended temperature range
- 100% Functional test – 5 years warranty

→ For the whole and update Device Manual refer to producer's website: <http://www.dalcnet.com>

➤ **CONSTANT CURRENT VARIANTS (common anode)**

Application (4 – channels output): Dimmer, Dim to warm, Tunable White, RGB, RGBW

CODE	Supply Voltage	Output	Channels	Command	
DLD1248-4CC-DMX	12-48V DC	1x1000-2800 mA	4	DMX N.O. push button / 0-10 / 1-10 / Pot 10kΩ	PROFESSIONAL
		4x250-700 mA			
DLD1248-4CC-MODBUS	12-48V DC	1x1000-2800 mA	4	MODBUS RTU N.O. push button / 0-10 / 1-10 / Pot 10kΩ	PROFESSIONAL
		4x250-700 mA			
DLD1248-4CC-DALI	12-48V DC	1x1000-2800 mA	4	DALI N.O. push button / 0-10 / 1-10 / Pot 10kΩ	PROFESSIONAL
		4x250-700 mA			

➤ **CONSTANT VOLTAGE VARIANTS (common anode)**

Application (4 – channels output): Dimmer, Dim to warm, Tunable White, RGB, RGBW

CODE	Supply Voltage	Output	Channels	Command	
DLD1248-4CV-DMX	12-48V DC	1x20A max	4	DMX N.O. push button / 0-10 / 1-10 / Pot 10kΩ	PROFESSIONAL
		4x5A max			
DLD1248-4CV-MODBUS	12-48V DC	1x20A max	4	MODBUS RTU N.O. push button / 0-10 / 1-10 / Pot 10kΩ	PROFESSIONAL
		4x5A max			
DLD1248-4CV-DALI	12-48V DC	1x20A max	4	DALI N.O. push button / 0-10 / 1-10 / Pot 10kΩ	PROFESSIONAL
		4x5A max			

➤ PROTECTIONS

		DLD1248-4CV	DLD1248-4CC
OTP	Over temperature protection ¹	✓	✓
OVP	Over voltage protection ²	✓	✓
UVP	Under voltage protection ²	✓	✓
RVP	Reverse polarity protection ²	✓	✓
IFP	Input fuse protection ²	✓	✓
SCP	Short circuit protection	✓	✗
OCF	Open circuit protection	✗	✓
CLP	Current limit protection	✓	✓

➤ REFERENCE STANDARDS

EN 61347-1	Lamp controlgear - Part 1: General and safety requirements
EN 55015	Limits and methods of measurement of radio disturbance characteristics of electrical lighting and similar equipment
EN 61547	Equipment for general lighting purposes - EMC immunity requirements
EN 50581	Technical documentation for the assessment of electrical and electronic products with respect to the restriction of hazardous substances
IEC/EN 62386-101	Digital addressable lighting interface - Part 101: General requirements - System
IEC/EN 62386-102	Digital addressable lighting interface - Part 102: General requirements - Control gear
IEC/EN 62386-207	Digital addressable lighting interface - Part 207: Particular requirements for control gear – LED modules (device type 6)
IEC 60929-E.2.1	Control interface for controllable ballasts - control by d.c. voltage - functional specification
ANSI E 1.3	Entertainment Technology - Lighting Control Systems - 0 to 10V Analog Control Specification
ANSI E1.11	Entertainment Technology - USITT DMX512-A - Asynchronous Serial Digital Data Transmission Standard for Controlling Lighting Equipment and Accessories
ANSI E1.20	Entertainment Technology-RDM-Remote Device Management over USITT DMX512 Networks
-	MODBUS APPLICATION PROTOCOL SPECIFICATION V1.1b

¹ Thermal Protection on the output channel in case of high temperature. The thermal intervention is detected by transistor (>150°C) or current regulation (depending of the booster variant).

² Only control logic protection



➤ TECHNICAL SPECIFICATION CONSTANT VOLTAGE OUTPUT

		Variant Constant Voltage	
Supply Voltage		DC min: 10.8 Vdc .. max: 52.8 Vdc	
Output Voltage		= Vin	
Input Current		max 20A	
Output Current ³		@ch	Total
		4x max 5 A	// 1 x max 20 A
Nominal Power ³	@12V	60 W/ch	240 W tot
	@24V	120 W/ch	480 W tot
	@48V	240 W/ch	960 W tot

➤ TECHNICAL SPECIFICATION CONSTANT VOLTAGE OUTPUT

		Variant Constant Current										
Supply Voltage		DC min: 10.8 Vdc .. max: 52.8 Vdc										
Output Voltage		min: Vin/4 – max: Vin-0,9V										
Input Current		max 2,8 A										
Output Current ³		@ch					Total					
		4x max 700 mA					// 1 x max 2,8 A					
Nominal Power @ at cannal ³	Current [mA]	250	300	350	400	450	500	550	600	650	700	
	Single Output @12V	3W	3,6W	4,2W	4,8W	5,4W	6W	6,6W	7,2W	7,8W	8,4W	
	@24V	6W	7,2W	8,4W	9,6W	10,8W	12W	13,2W	14,4W	15,6W	16,8W	
	@48V	12W	14,4W	16,8W	19,2W	21,6W	24W	26,4W	28,8W	31,2W	33,6W	
Nominal Power ³	Current [mA]	250	300	350	400	450	500	550	600	650	700	
	Total Output @12V	12W	14,4W	16,8W	19,2W	21,6W	24W	26,4W	28,8W	31,2W	33,6W	
	@24V	24W	28,8W	33,6W	38,4W	43,2W	48W	52,8W	57,6W	62,4W	67,2W	
	@48V	48W	57,6W	67,2W	76,8W	86,4W	96W	105,6W	115,2W	124,8W	134,4W	

➤ TECHNICAL SPECIFICATION CONSTANT VOLTAGE OUTPUT

Power loss in standby mode	<500mW
Type Load	R – L – C
Thermal Shutdown ⁴	150 °C
D-PWM Dimming Frequency	300Hz – 600Hz – 1200Hz
D-PWM Resolution	16 bit
D-PWM Range	0,1% - 100%
Storage Temperature	min: -40 max: +60 °C
Ambient Temperature	min: -40 max: +60 °C
Wiring	Buttons & Bus: 1.5 mm ² solid - 1mm ² stranded - 30/14 AWG Power & Leds: 2.5 mm ² solid – 1.5mm ² stranded - 30/12 AWG
Wire preparation length	Buttons & Bus: 6 mm Power & Leds: 7,5 mm
Protection Grade	IP10
Casing material	Plastic
Packaging unit (pieces/unit)	Single Carton Box - 1pz Carton Box 4 pz
Mechanical Dimension	72 x 92 x 62 mm – DIN RAIL 4mod.
Packaging Dimension	124 x 85 x 71 mm 263 x 178 x 82 mm
Weight	125g 800g

³ Maximum value, dependent on the ventilation conditions⁴ Thermal Protection on the output channel in case of high temperature. The thermal intervention is detected by transistor (>150°C) or current regulation (depending of the booster variant).

➤ **INSTALLATION**

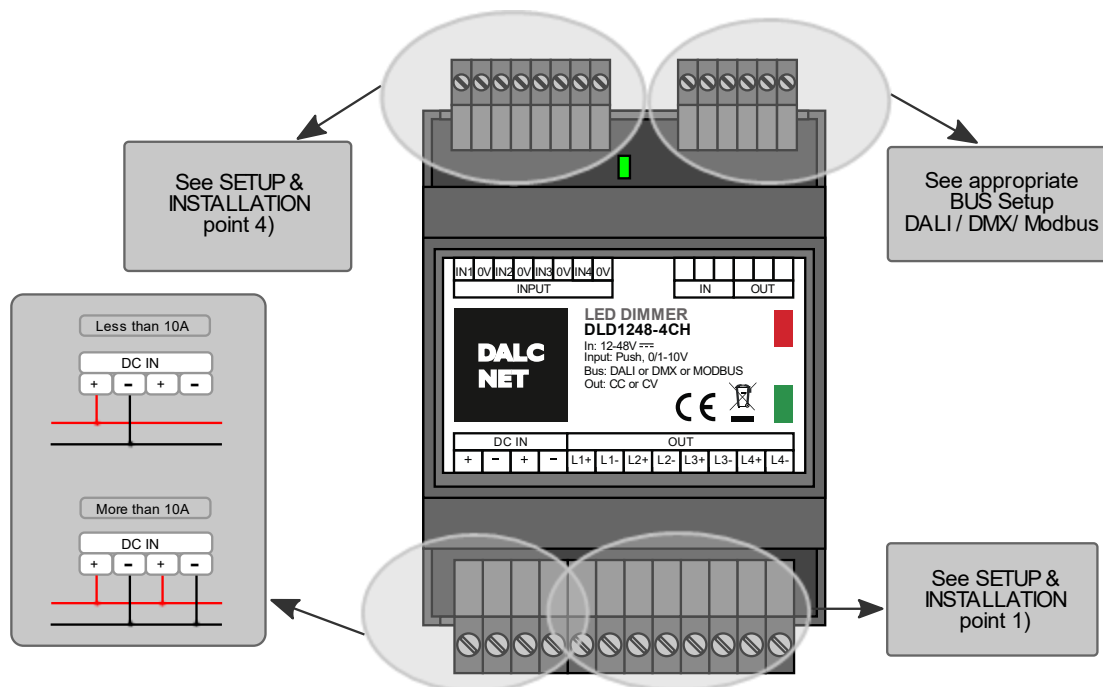

➤ **MECHANICAL DIMENSION:**
(without connectors)

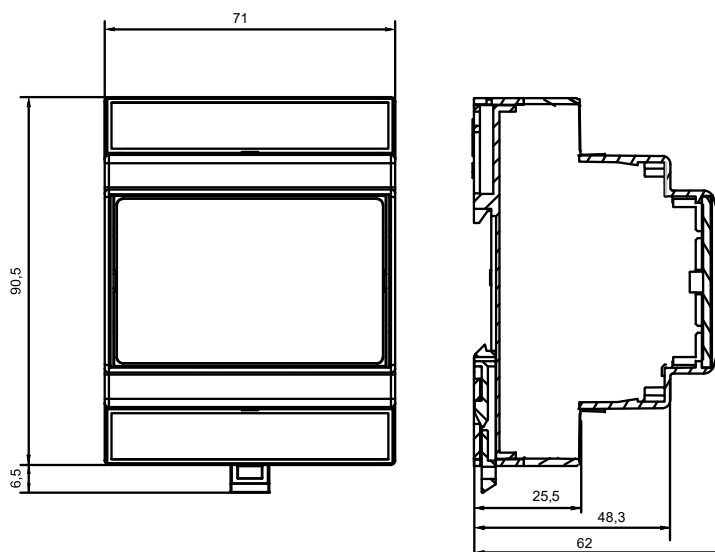

➤ OPENING THE COVER

For the Dip-switch and selectors configuration it is necessary to pull up the cover of the device. See the picture.

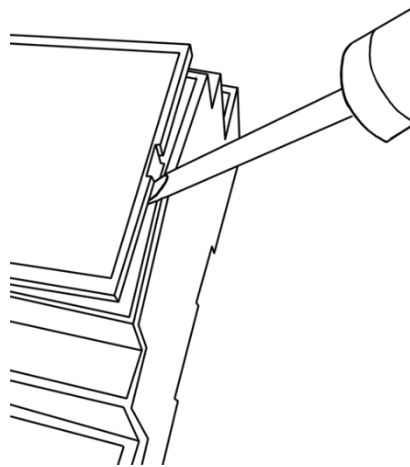

➤ TECHNICAL NOTES

Installation:

- Installation and maintenance must be performed only by qualified personnel in compliance with current regulations.
- The product must be installed inside an electrical panel protected against overvoltages.
- The product must be installed in a vertical or horizontal position with the cover / label upwards or vertically; Other positions are not permitted. It is not permitted to bottom-up position (with the cover / label down).
- Keep separated the circuits at 230V (LV) and the circuits not SELV from circuits to low voltage (SELV) and from any connection with this product. It is absolutely forbidden to connect, for any reason whatsoever, directly or indirectly, the 230V mains voltage to the bus or to other parts of the circuit.

Power supply:

- For the power supply use only a SELV power supplies with limited current, short circuit protection and the power must be dimensioned correctly. In case of using power supply with ground terminals, all points of the protective earth (PE = Protection Earth) must be connected to a valid and certified protection earth.
- The connection cables between the power source "low voltage" and the product must be dimensioned correctly and they should be isolated from every wiring or parts at voltage not SELV. Use double insulated cables.
- In the event of higher than 10A total output current to plug into both power input pairs "V+" and "V-".
- Dimension the power supply for the load connected to the device. If the power supply is oversized compared with the maximum absorbed current, insert a protection against over-current between the power supply and the device.
- For the constant current output, the voltage of LED module (Vf) must be less of 5V at the voltage of power supply.

Command:

- The length of the connection cables between the local commands (N.O. Push button, 0-10V, 1-10V, Potentiometer or other) and the product must be less than 10m; the cables must be dimensioned correctly and they should be isolated from every wiring or parts at voltage not SELV. Use double insulated shielded and twisted cables.
- The length and type of the connection cables at the BUS (DMX512, Modbus, DALI, Ethernet, or other) use cables as per specification of the respective protocols and regulations and they should be isolated from every wiring or parts at voltage not SELV. It is suggested to use double insulated shielded and twisted cables.
- All devices a related control signal to the bus (DMX512, Modbus, DALI, Ethernet or other) and at the local command (N.O. Push button, 0-10V, 1-10V, Potentiometer or other) must be SELV (the devices connected must be SELV or supply a SELV signal)

Outputs:

- It is suggesting the length of the connection cables between the product and the LED module must be less than 10m; the cables must be dimensioned correctly and they should be isolated from every wiring or parts at voltage not SELV. It is suggested to use double insulated shielded and twisted cables. In case you want to connection the product to LED modules with cables longer than 10m, the installer must guarantee the correct functioning of the system. In any case, do not exceed 30m of the connection between the product and the LED modules.

➤ SETUP & INSTALLATION

A 12 way dip-switch (under the cover) can provide a rich set of possible configurations:

Note: Factory positions = all OFF

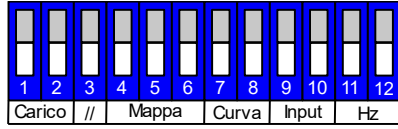
Function		<ul style="list-style-type: none"> • Switches from 1 to 2: Load Type • Switch 3: Parallel Outputs • Switches from 4 to 6: Map • Switches from 7 to 8: Curve • Switches from 9 to 10: Input Type • Switches from 11 to 12: Output frame rate (freq.)
----------	---	---



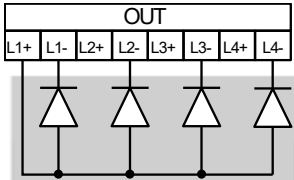
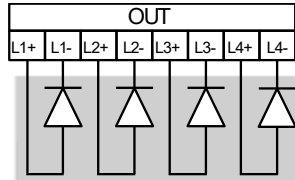
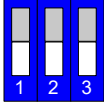
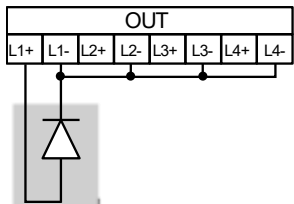
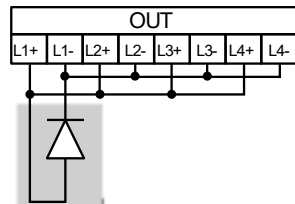
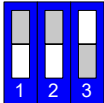
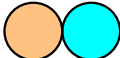
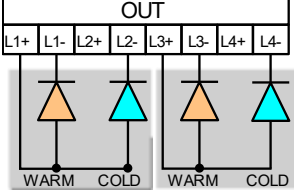
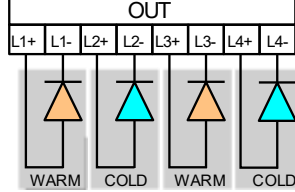
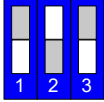
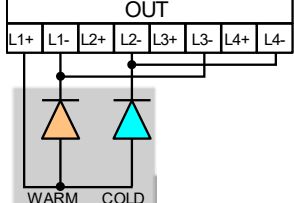
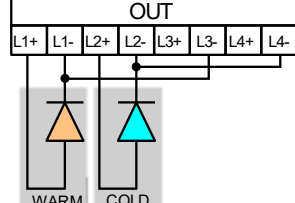
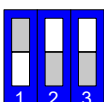
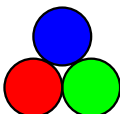
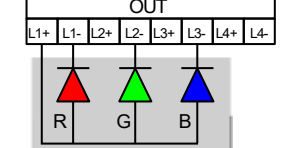
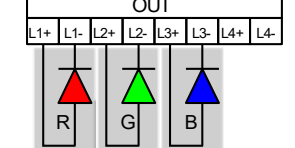
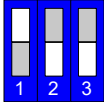
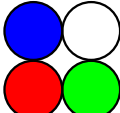
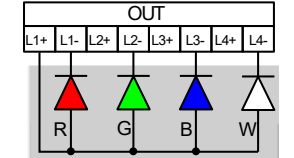
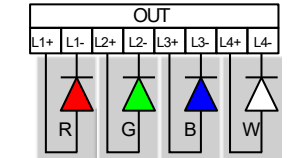
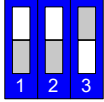







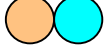











1) Select Load Type and Parallel Out depending on output connections: Switches from 1 to 2 and Switch 3

Load Type	Description	Connections (Total current 0 - 10A max)	Connections (Total current 0 - 20A max)	Settings
	White, up to 4 loads			
	White, parallel outputs with increased current (Macro dimmer)			
	Tunable White, up to 2 loads			
	Tunable White, parallel output pairs with increased current			
	RGB			
	RGBW			





Note: Set the "Select Map" according to the connected load and the function you want. See "Map Setting" page 7.



2) Select Map: Switches from 4 to 6

White Load 	Tunable White Load 	RGB Load 	RGBW Load 
Dimmer 	Dimmer 	Dimmer 	Dimmer 
	Dim to Warm 	Dim to Warm 	Dim to Warm 
	Tunable White 	Tunable White 	Tunable White 
		Smart HSV Intensity, temperature correction, color hue & rotation, saturation and strobe 	Smart HSV Intensity, temperature correction, color hue & rotation, saturation and strobe 
		RGB 	RGB Convert RGB→RGBW 
		RGBW Convert RGBW→RGB 	RGBW 
		Master+RGB+Strobe 	Master+RGB+Strobe Convert RGB→RGBW 
		Master+RGBW+Strobe Convert RGBW→RGB 	Master+RGBW+Strobe 

3) Select Dimming Curve: Switches from 7 to 8

Default (by bus type) 	Quadratic 	Exponential 	Linear 
---	--	--	--



4) Select Local Input Type: Switches from 9 to 10

In Type	Description	Connections	Setting
Push	N.O. Pushbutton, NO memory		
	N.O. Pushbutton, MEMORY		
0-10V	Analogic 0-10V		
1-10V	Analogic 1-10V & Potentiometer		

5) Set Output Frequency: Switches from 11 to 12

300Hz		600Hz		1200Hz		Reserved	
-------	--	-------	--	--------	--	----------	--

➤ OUTPUT CURRENT REGULATION





































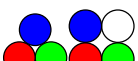





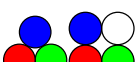

Function implementation only for current variant: DLD1248-4CC-DMX; DLD1248-4CC-MODBUS; DLD1248-4CC-DALI.

To set the Trimmer it is necessary to open the front panel of the device. See figure pag5.

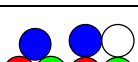
	Trimmer Setting	Current Value
Position 1		250mA
Position 2		300mA
Position 3		350mA
Position 4		400mA
Position 5		450mA

	Trimmer Setting	Current Value
Position 6		500mA
Position 7		550mA
Position 8		600mA
Position 9		650mA
Position 10		700mA

➤ **LOCAL COMMANDS FUNCTIONALITY ACCORDING TO THE SELECTED MAP**





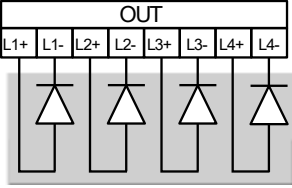
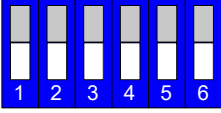
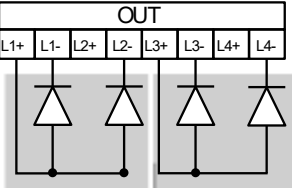
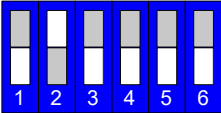
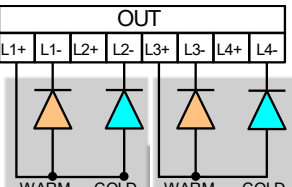
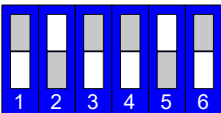
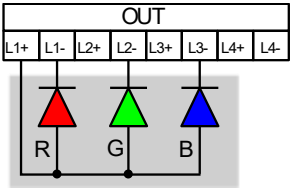
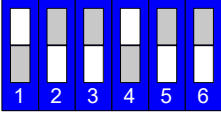
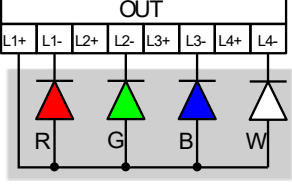
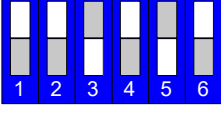



Load Type	Map	IN 1	IN 2	IN 3	IN 4
 White Up to 4 loads	Dimmer	Dim1 	Dim2 	Dim3 	Dim4 
 White Parallel outs	Dimmer	Dimmer 			
 Tunable white Up to 2 loads	Dimmer	Dim1 	Dim2 		
 Tunable white Parallel outs	Dimmer	Dimmer 			
 Tunable white Up to 2 loads	Dim to Warm	Dim1 to Warm 	Dim2 to Warm 		
 Tunable white Parallel outs	Dim to Warm	Dimmer to Warm 			
 Tunable white Up to 2 loads	Tunable White	Dim1 	CCT1 	Dim2 	CCT2 
 Tunable white Parallel outs	Tunable White	Dimmer 	CCT 		
 RGB & RGBW	Dimmer	Dimmer 			
 RGB & RGBW	Dim to Warm	Dimmer to Warm 			
 RGB & RGBW	Tunable White	Dimmer 	CCT 		
 RGB & RGBW	Smart HSV	Dimmer 	CCT 	Colore 	Saturation 
 RGB & RGBW	RGB	Red 	Green 	Blue 	
 RGB & RGBW	RGBW	Red 	Green 	Blue 	White 
 RGB & RGBW	MRGB+	Red 	Green 	Blue 	
 RGB & RGBW	MRGBW+	Red 	Green 	Blue 	White 

EXAMPLE OF MAP SETTINGS

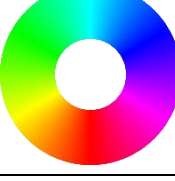

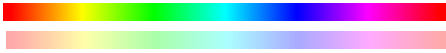
Command	Connections	Settings
White, up to 4 loads		
Group control IN1 INPUT: command simultaneous piloting of output L1 and L2 IN2 INPUT: command simultaneous piloting of output L3 and L4		
Tunable White, up to 2 loads		
RGB		
RGBW		

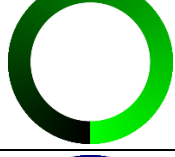
➤ **LOCAL INPUTS**

Available Functions: N.O. PUSH BUTTON memory / N.O. PUSH BUTTON no memory:

	<p>Dimmer Dim the light following the selected dimming curve, keeping a constant color temperature. Soft Turn On with 200ms fade time, Soft Turn Off with 1s fade time.</p> <p>Click: Turn ON/OFF light. Double Click: Turn On light at 100% Long pressure (>1s) from OFF: Turn on at 1% (Nighttime) Long pressure (>1s) from ON: Dimmer UP/DOWN</p>										
	<p>Dim to Warm Dim the light following the selected dimming curve. The color temperature increase with intensity. Soft Turn On with 200ms fade time, Soft Turn Off with 1s fade time.</p> <p>Click: Turn ON/OFF light. Double Click: Turn On light at 100% Long pressure (>1s) from OFF: Turn on at 1% (Nighttime) Long pressure (>1s) from ON: Dimmer UP/DOWN</p>										
	<p>CCT: Color Correction Temperature / White Balance -Tunable White load: change the color temperature, keeping a constant intensity. Neutral white is 50% cold + 50% warm. -RGB load: change the equivalent color temperature. Neutral white is an equal value to R,G,B. -RGBW load: balance the white from the white output to the composite RGB output. Neutral white is 50% white + 50% R+G+B.</p> <p>Double Click: Neutral white Long pressure (>1s) from OFF: Change Colour Temperature UP/DOWN (Cold ↔ Warm or White ↔ R+G+B)</p>										
	<p>Color rotation and selection Change the colour or colour rotation speed.</p> <table border="1" data-bbox="1067 976 1489 1149"> <thead> <tr> <th>Rotation Speed</th> <th>Strobe Pulse</th> </tr> </thead> <tbody> <tr> <td>6 seconds</td> <td>10 flashes/sec.</td> </tr> <tr> <td>30 seconds</td> <td>5 flashes /sec.</td> </tr> <tr> <td>6 minutes</td> <td>2 flashes /sec.</td> </tr> <tr> <td>30 minutes</td> <td>1 flashes /sec.</td> </tr> </tbody> </table> <p>Click: Start/Stop color rotation. Double Click: Change from color (or color rotation) to white and vice-versa. Long pressure (>1s) from ON: Change the rotation speed, selected from 4 predefined levels. The selected speed is visualized as a white strobe light.</p>	Rotation Speed	Strobe Pulse	6 seconds	10 flashes/sec.	30 seconds	5 flashes /sec.	6 minutes	2 flashes /sec.	30 minutes	1 flashes /sec.
Rotation Speed	Strobe Pulse										
6 seconds	10 flashes/sec.										
30 seconds	5 flashes /sec.										
6 minutes	2 flashes /sec.										
30 minutes	1 flashes /sec.										
	<p>Color saturation: Change the color saturation: vivid color ↔ pastel color.</p> <p>Click: Toggle between white and colors. Double Click: Maximum saturation – Vivid Colors. Long pressure (>1s) from white: Minimum saturation – Pastel Colors. Long pressure (>1s) from colour: Change the saturation value.</p> 										
	<p>Red: linear change red channel.</p> <p>Click: Turn ON/OFF light. Double Click: Turn On light at 100% Long pressure (>1s) from OFF: Turn on at 1% Long pressure (>1s) from ON: Dimmer UP/DOWN</p>										
	<p>Green: linear change green channel.</p> <p>Click: Turn ON/OFF light. Double Click: Turn On light at 100% Long pressure (>1s) from OFF: Turn on at 1% Long pressure (>1s) from ON: Dimmer UP/DOWN</p>										
	<p>Blue: linear change blue channel.</p> <p>Click: Turn ON/OFF light. Double Click: Turn On light at 100% Long pressure (>1s) from OFF: Turn on at 1% Long pressure (>1s) from ON: Dimmer UP/DOWN</p>										
	<p>White: linear change white channel.</p> <p>Click: Turn ON/OFF light. Double Click: Turn On light at 100% Long pressure (>1s) from OFF: Turn on at 1% Long pressure (>1s) from ON: Dimmer UP/DOWN</p>										

Available functions: 0-10V / 1-10V / potentiometer:

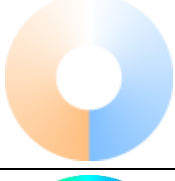
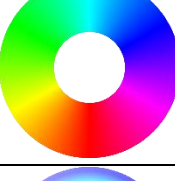
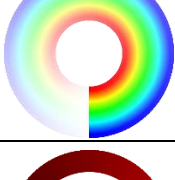
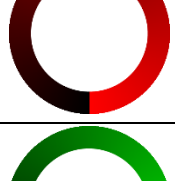
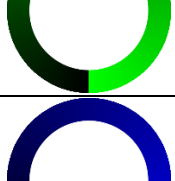
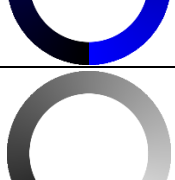
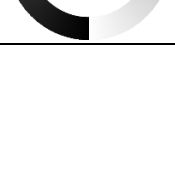
	<p>Dimmer Dim the light following the selected dimming curve, keeping a constant color temperature. Minimum intensity =0.1%</p> <p>Below 1V = Turn OFF light. 10V = Maximum intensity</p>
	<p>Dim to Warm Dim the light following the selected dimming curve. The color temperature increased with intensity. Minimum intensity =0.1%</p> <p>Below 1V = Turn OFF light. 10V = Maximum intensity</p>
	<p>CCT: Color Correction Temperature / White Balance -Tunable White load: change the color temperature, keeping a constant intensity. Neutral white is 50% cold + 50% warm. -RGB load: change the equivalent color temperature. Neutral white is an equal value to R,G,B. -RGBW load: balance the white from the white output to the composite RGB output. Neutral white is 50% white + 50% R+G+B.</p> <p>Change the color temperature from warm (1V), to cold (10V).</p>
	<p>Color rotation and selection Change the color.</p> <p>Select a color starting from red (1V), then yellow, green, cyan, blue, magenta and red again (10V).</p>
	<p>Color saturation: Change the colour saturation: vivid colours ↔ pastel colours</p> <p>Change the saturation from white (1V) to vivid colours (10V).</p>
	<p>Red: linear change red channel.</p> <p>Below 1V = Turn OFF light. 10V = Maximum intensity</p>
	<p>Green: linear change green channel.</p> <p>Below 1V = Turn OFF light. 10V = Maximum intensity</p>
	<p>Blue: linear change blue channel.</p> <p>Below 1V = Turn OFF light. 10V = Maximum intensity</p>
	<p>White: linear change white channel.</p> <p>Below 1V = Turn OFF light. 10V = Maximum intensity</p>

➤ DALI BUS SETUP

In **DALI BUS SETUP** all the leds are controlled by an external DALI controller.

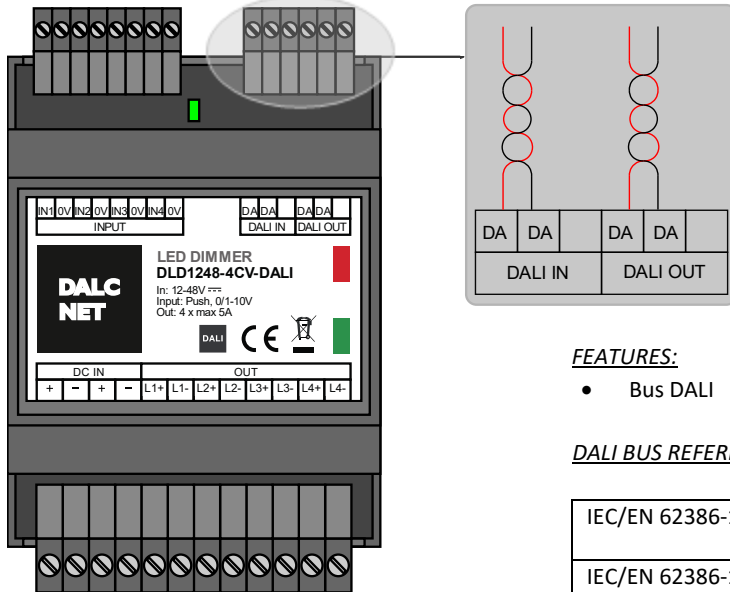

FEATURES:

- Bus DALI

DALI BUS REFERENCE STANDARDS

IEC/EN 62386-101	Digital addressable lighting interface - Part 101: General requirements - System
IEC/EN 62386-102	Digital addressable lighting interface - Part 102: General requirements - Control gear
IEC/EN 62386-207	Digital addressable lighting interface - Part 207: Particular requirements for control gear – LED modules (device type 6)

ONBOARD LED:

- In the case of no bus power detected, or bus error, the led blinks fast (2 pulsed per second).
- In the case of bus power but no data, led blinks slow (1 pulse per second).
- In the case of data link active, the led stands on.

RELATION WITH LOCAL COMMANDS:

- At power-up, in case of absence of connection to the BUS, local control is active.
- When the BUS is detected, the control passes to the BUS. It remains to the BUS until there is signal.
- In the absence of signal:
 - if the local command is N.O. PUSH BUTTON, the control passes to local command in the event of a N.O. push button pressure.
 - if the local command is 0-10V or 1-10V the control passes immediately to the local command.

ADDRESSING

By selectors	✓
Simplified method (One ballast connected at a time)	✓
Random Address Allocation	✓

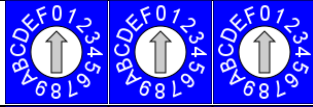
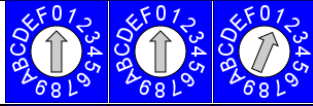
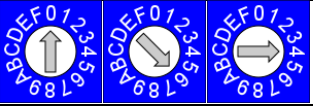
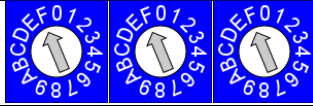
DALI	000 (Default)			Address defined by DALI	
	from 001		to 064		First channel address, from 1 to 64
	FFF				(reserved)

➤ CHANNELS MAP – DALI

 Load Type: White – up to 4 loads

Addr	Function	Map: Dimmer
+0	Dimmer 1	Dimmer (Brightness Value) 0 .. 254
+1	Dimmer 2	Dimmer (Brightness Value) 0 .. 254
+2	Dimmer 3	Dimmer (Brightness Value) 0 .. 254
+3	Dimmer 4	Dimmer (Brightness Value) 0 .. 254

 Load Type: White – Parallel outs (Macro dimmer)

Addr	Function	Map: Dimmer
+0	Dimmer	Dimmer (Brightness Value) 0 .. 254

 Load Type: Tunable White – up to 2 loads

Addr	Function	Map: Dimmer
+0	Dimmer 1	Dimmer (Brightness Value) 0 .. 254
+1	Dimmer 2	Dimmer (Brightness Value) 0 .. 254

Addr	Function	Map: Dim to Warm
+0	Dimmer 1	Dimmer (Brightness Value) 0 .. 254
+1	Dimmer 2	Dimmer (Brightness Value) 0 .. 254

Addr	Function	Map: Tunable white
+0	Dimmer 1	Dimmer (Brightness Value) 0 .. 254
+1	Color Correction 1	Color correction temperature 0 .. 254
+2	Dimmer 2	Dimmer (Brightness Value) 0 .. 254
+3	Color Correction 2	Color correction temperature 0 .. 254

 Load Type: Tunable White – Parallel outs

Addr	Function	Map: Dimmer
+0	Dimmer	Dimmer (Brightness Value) 0 .. 254

Addr	Function	Map: Dim to Warm
+0	Dimmer	Dimmer (Brightness Value) 0 .. 254

Addr	Function	Map: Tunable white
+0	Dimmer	Dimmer (Brightness Value) 0 .. 254
+1	Color Correction	Color correction temperature 0 .. 254

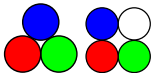

Load Type: RGB & RGBW

Addr	Function	Map: Dimmer
+0	Master Dimmer	Dimmer (Brightness Value) 0 .. 254

Addr	Function	Map: Dim to Warm
+0	Master Dimmer	Dimmer (Brightness Value) 0 .. 254

Addr	Function	Map: Tunable white
+0	Master Dimmer	Dimmer (Brightness Value) 0 .. 254
+1	Color Correction	Color correction temperature 0 .. 254

Addr	Function	Smart HSV																																
+0	Master Dimmer	Dimmer (Brightness Value) 0 .. 254																																
+1	Color Correction	Color correction temperature 0 .. 254																																
+2	Hue	Hue 0 .. 254																																
+3	Hue Rotation (rainbow) Time	<table border="1" style="width: 100%; text-align: center;"> <tr> <td>Hue Fine</td> <td>Hold</td> <td>30min</td> <td>15min</td> <td>6min</td> <td>3min</td> <td>1min</td> <td>30s</td> <td>15s</td> <td>6s</td> <td>3s</td> </tr> <tr> <td>0 ... 15</td> <td>16 ... 25</td> <td>26 .. 51</td> <td>52 .. 76</td> <td>77 .. 102</td> <td>103..127</td> <td>128..153</td> <td>154..179</td> <td>180..204</td> <td>205..230</td> <td>231..254</td> </tr> </table>	Hue Fine	Hold	30min	15min	6min	3min	1min	30s	15s	6s	3s	0 ... 15	16 ... 25	26 .. 51	52 .. 76	77 .. 102	103..127	128..153	154..179	180..204	205..230	231..254										
Hue Fine	Hold	30min	15min	6min	3min	1min	30s	15s	6s	3s																								
0 ... 15	16 ... 25	26 .. 51	52 .. 76	77 .. 102	103..127	128..153	154..179	180..204	205..230	231..254																								
+4	Saturation	Saturation 0 .. 254																																
+5	Strobo Rate	<table border="1" style="width: 100%; text-align: center;"> <tr> <td>fix</td> <td>blackout</td> <td>1fps</td> <td>2fps</td> <td>3fps</td> <td>4fps</td> <td>5fps</td> <td>6fps</td> <td>7fps</td> <td>8fps</td> <td>9fps</td> <td>10fps</td> <td>12fps</td> <td>14fps</td> <td>16fps</td> <td>fix</td> </tr> <tr> <td>0..15</td> <td>16..31</td> <td>32..47</td> <td>48..63</td> <td>64..79</td> <td>80..95</td> <td>96..111</td> <td>112..127</td> <td>128..143</td> <td>144..159</td> <td>160..175</td> <td>176..191</td> <td>192..207</td> <td>208..223</td> <td>224..239</td> <td>240..254</td> </tr> </table>	fix	blackout	1fps	2fps	3fps	4fps	5fps	6fps	7fps	8fps	9fps	10fps	12fps	14fps	16fps	fix	0..15	16..31	32..47	48..63	64..79	80..95	96..111	112..127	128..143	144..159	160..175	176..191	192..207	208..223	224..239	240..254
fix	blackout	1fps	2fps	3fps	4fps	5fps	6fps	7fps	8fps	9fps	10fps	12fps	14fps	16fps	fix																			
0..15	16..31	32..47	48..63	64..79	80..95	96..111	112..127	128..143	144..159	160..175	176..191	192..207	208..223	224..239	240..254																			

Addr	Function	Map: RGB
+0	R	R 0 .. 254
+1	G	G 0 .. 254
+2	B	B 0 .. 254

Addr	Function	Map: RGBW
+0	R	R 0 .. 254
+1	G	G 0 .. 254
+2	B	B 0 .. 254
+3	W	W 0 .. 254

Addr	Function	Map: MRGB+																
+0	Master Dimmer	Master Dimmer (Brightness Value) 0 .. 254																
+1	R	R 0 .. 254																
+2	G	G 0 .. 254																
+3	B	B 0 .. 254																
+4	Strobo Rate	<table border="1" style="width: 100%; text-align: center;"> <tr> <td>Fix</td> <td>blackout</td> <td>1fps</td> <td>2fps</td> <td>3fps</td> <td>4fps</td> <td>5fps</td> <td>6fps</td> <td>7fps</td> <td>8fps</td> <td>9fps</td> <td>10fps</td> <td>12fps</td> <td>14fps</td> <td>16fps</td> <td>fix</td> </tr> </table>	Fix	blackout	1fps	2fps	3fps	4fps	5fps	6fps	7fps	8fps	9fps	10fps	12fps	14fps	16fps	fix
Fix	blackout	1fps	2fps	3fps	4fps	5fps	6fps	7fps	8fps	9fps	10fps	12fps	14fps	16fps	fix			

Addr	Function	Map: MRGBW+																
+0	Master Dimmer	Master Dimmer (Brightness Value) 0 .. 254																
+1	R	R 0 .. 254																
+2	G	G 0 .. 254																
+3	B	B 0 .. 254																
+4	W	W 0 .. 254																
+5	Strobo Rate	<table border="1" style="width: 100%; text-align: center;"> <tr> <td>Fix</td> <td>blackout</td> <td>1fps</td> <td>2fps</td> <td>3fps</td> <td>4fps</td> <td>5fps</td> <td>6fps</td> <td>7fps</td> <td>8fps</td> <td>9fps</td> <td>10fps</td> <td>12fps</td> <td>14fps</td> <td>16fps</td> <td>fix</td> </tr> </table>	Fix	blackout	1fps	2fps	3fps	4fps	5fps	6fps	7fps	8fps	9fps	10fps	12fps	14fps	16fps	fix
Fix	blackout	1fps	2fps	3fps	4fps	5fps	6fps	7fps	8fps	9fps	10fps	12fps	14fps	16fps	fix			



➤ DMX+RDM BUS SETUP

With the **DMX+RDM BUS** in the “slave” condition the outputs are managed by an external DMX controller.
In the “master” condition, the DMX+RDM allows the communications between devices.

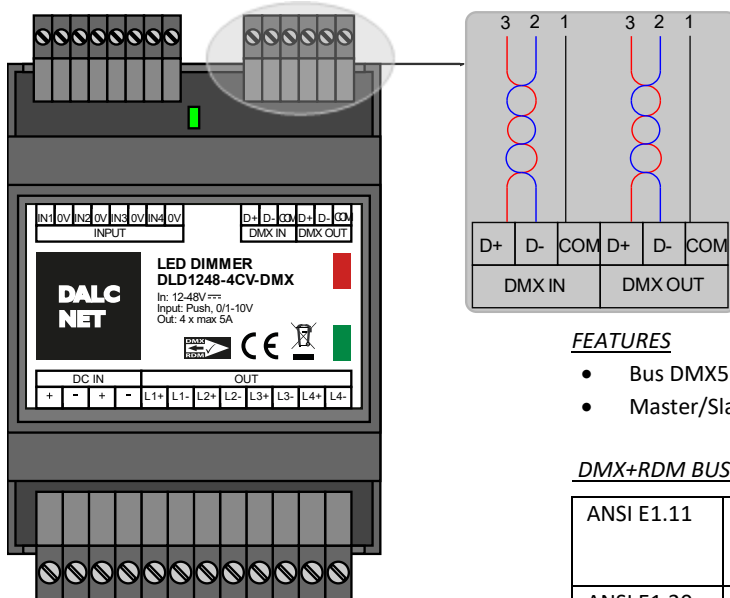

Use	3-Pin XLR Pin #	DMX512 Function
Common Reference	1	Data Link Common
Primary Data Link	2	Data 1-
	3	Data 1+
Secondary Data Link (Optional – see clause 4.8)	4	Data 2-
	5	Data 2+

FEATURES

- Bus DMX512-A (NSC+RDM)
- Master/Slave

DMX+RDM BUS REFERENCE STANDARDS

ANSI E1.11	Entertainment Technology - USITT DMX512-A - Asynchronous Serial Digital Data Transmission Standard for Controlling Lighting Equipment and Accessories
ANSI E1.20	Entertainment Technology-RDM-Remote Device Management over USITT DMX512 Networks

TECHNICAL SPECIFICATIONS

Standard DMX512-A/RDM

ONBOARD LED:

- In the case of bus error, the led blinks fast (2 pulsed per second).
- In the case of no bus detected, led blinks slow (1 pulse per second).
- In the case of data link active, the led stands on.

RELATION WITH LOCAL COMMANDS:

- At power-up, in case of absence of connecting to the BUS, local control is active.
- When the BUS is detected, the control passes to the BUS. It remains to the BUS until there is signal.
- In the absence of signal:
 - if the local command is N.O. PUSH BUTTON, the control passes to local command in the event of a N.O. push button pressure.
 - if the local command is 0-10V or 1-10V the control passes immediately to the local command.

ADDRESSING

RDM	✓
By selectors	✓

DMX	000 (Default)		Addressing set by RDM protocol	
	from 001		to	DMX addressing from 1 to 512
	F00		MASTER	

➤ CHANNELS MAP – DMX512

○ Load Type: White – up to 4 loads

Ch.	Function	Map: Dimmer
1	Dimmer 1	Dimmer (Brightness Value) 0 .. 255
2	Dimmer 2	Dimmer (Brightness Value) 0 .. 255
3	Dimmer 3	Dimmer (Brightness Value) 0 .. 255
4	Dimmer 4	Dimmer (Brightness Value) 0 .. 255

○ Load Type: White – Parallel outs (Macro dimmer)

Ch.	Function	Map: Dimmer
1	Dimmer	Dimmer (Brightness Value) 0 .. 255

●● Load Type: Tunable White – up to 2 loads

Ch.	Function	Map: Dimmer
1	Dimmer 1	Dimmer (Brightness Value) 0 .. 255
2	Dimmer 2	Dimmer (Brightness Value) 0 .. 255

Ch.	Function	Map: Dim to Warm
1	Dimmer 1	Dimmer (Brightness Value) 0 .. 255
2	Dimmer 2	Dimmer (Brightness Value) 0 .. 255

Ch.	Function	Map: Tunable white
1	Dimmer 1	Dimmer (Brightness Value) 0 .. 255
2	Color Correction 1	Color correction temperature 0 .. 255
3	Dimmer 2	Dimmer (Brightness Value) 0 .. 255
4	Color Correction 2	Color correction temperature 0 .. 255

●● Load Type: Tunable White – Parallel outs

Ch.	Function	Map: Dimmer
1	Dimmer	Dimmer (Brightness Value) 0 .. 255

Ch.	Function	Map: Dim to Warm
1	Dimmer	Dimmer (Brightness Value) 0 .. 255

Ch.	Function	Map: Tunable white
1	Dimmer	Dimmer (Brightness Value) 0 .. 255
2	Color Correction	Color correction temperature 0 .. 255

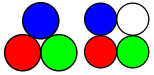

Load Type: RGB & RGBW

Ch.	Function	Map: Dimmer
1	Master Dimmer	Dimmer (Brightness Value) 0 .. 255

Ch.	Function	Map: Dim to Warm
1	Master Dimmer	Dimmer (Brightness Value) 0 .. 255

Ch.	Function	Map: Tunable white
1	Master Dimmer	Dimmer (Brightness Value) 0 .. 255
2	Color Correction	Color correction temperature 0 .. 255

Ch.	Function	Map: Smart HSV																																
1	Master Dimmer	Dimmer (Brightness Value) 0 .. 255																																
2	Color Correction	Color correction temperature 0 .. 255																																
3	Hue	Hue 0 .. 255																																
4	Hue Rotation (rainbow) Time	<table border="1" style="font-size: small; width: 100%;"> <tr> <td>Hue Fine</td> <td>Hold</td> <td>30min</td> <td>15min</td> <td>6min</td> <td>3min</td> <td>1min</td> <td>30s</td> <td>15s</td> <td>6s</td> <td>3s</td> </tr> <tr> <td>0 ... 15</td> <td>16 ... 25</td> <td>26 .. 51</td> <td>52 .. 76</td> <td>77 .. 102</td> <td>103..127</td> <td>128..153</td> <td>154..179</td> <td>180..204</td> <td>205..230</td> <td>231..254</td> </tr> </table>	Hue Fine	Hold	30min	15min	6min	3min	1min	30s	15s	6s	3s	0 ... 15	16 ... 25	26 .. 51	52 .. 76	77 .. 102	103..127	128..153	154..179	180..204	205..230	231..254										
Hue Fine	Hold	30min	15min	6min	3min	1min	30s	15s	6s	3s																								
0 ... 15	16 ... 25	26 .. 51	52 .. 76	77 .. 102	103..127	128..153	154..179	180..204	205..230	231..254																								
5	Saturation	Saturation 0 .. 255																																
6	Strobo Rate	<table border="1" style="font-size: x-small; width: 100%;"> <tr> <td>fix</td> <td>blackout</td> <td>1fps</td> <td>2fps</td> <td>3fps</td> <td>4fps</td> <td>5fps</td> <td>6fps</td> <td>7fps</td> <td>8fps</td> <td>9fps</td> <td>10fps</td> <td>12fps</td> <td>14fps</td> <td>16fps</td> <td>fix</td> </tr> <tr> <td>0..15</td> <td>16..31</td> <td>32..47</td> <td>48..63</td> <td>64..79</td> <td>80..95</td> <td>96..111</td> <td>112..127</td> <td>128..143</td> <td>144..159</td> <td>160..175</td> <td>176..191</td> <td>192..207</td> <td>208..223</td> <td>224..239</td> <td>240..254</td> </tr> </table>	fix	blackout	1fps	2fps	3fps	4fps	5fps	6fps	7fps	8fps	9fps	10fps	12fps	14fps	16fps	fix	0..15	16..31	32..47	48..63	64..79	80..95	96..111	112..127	128..143	144..159	160..175	176..191	192..207	208..223	224..239	240..254
fix	blackout	1fps	2fps	3fps	4fps	5fps	6fps	7fps	8fps	9fps	10fps	12fps	14fps	16fps	fix																			
0..15	16..31	32..47	48..63	64..79	80..95	96..111	112..127	128..143	144..159	160..175	176..191	192..207	208..223	224..239	240..254																			

Ch.	Function	Map: RGB
1	R	R 0 .. 255
2	G	G 0 .. 255
3	B	B 0 .. 255

Ch.	Function	Map: RGBW
1	R	R 0 .. 255
2	G	G 0 .. 255
3	B	B 0 .. 255
4	W	W 0 .. 255

Ch.	Function	Map: MRGB+																																
1	Master Dimmer	Master Dimmer (Brightness Value) 0 .. 255																																
2	R	R 0 .. 255																																
3	G	G 0 .. 255																																
4	B	B 0 .. 255																																
5	Strobo Rate	<table border="1" style="font-size: x-small; width: 100%;"> <tr> <td>Fix</td> <td>blackout</td> <td>1fps</td> <td>2fps</td> <td>3fps</td> <td>4fps</td> <td>5fps</td> <td>6fps</td> <td>7fps</td> <td>8fps</td> <td>9fps</td> <td>10fps</td> <td>12fps</td> <td>14fps</td> <td>16fps</td> <td>fix</td> </tr> <tr> <td>0..15</td> <td>16..31</td> <td>32..47</td> <td>48..63</td> <td>64..79</td> <td>80..95</td> <td>96..111</td> <td>112..127</td> <td>128..143</td> <td>144..159</td> <td>160..175</td> <td>176..191</td> <td>192..207</td> <td>208..223</td> <td>224..239</td> <td>240..254</td> </tr> </table>	Fix	blackout	1fps	2fps	3fps	4fps	5fps	6fps	7fps	8fps	9fps	10fps	12fps	14fps	16fps	fix	0..15	16..31	32..47	48..63	64..79	80..95	96..111	112..127	128..143	144..159	160..175	176..191	192..207	208..223	224..239	240..254
Fix	blackout	1fps	2fps	3fps	4fps	5fps	6fps	7fps	8fps	9fps	10fps	12fps	14fps	16fps	fix																			
0..15	16..31	32..47	48..63	64..79	80..95	96..111	112..127	128..143	144..159	160..175	176..191	192..207	208..223	224..239	240..254																			

Ch.	Function	Map: MRGBW+																																
1	Master Dimmer	Master Dimmer (Brightness Value) 0 .. 255																																
2	R	R 0 .. 255																																
3	G	G 0 .. 255																																
4	B	B 0 .. 255																																
5	W	W 0 .. 255																																
6	Strobo Rate	<table border="1" style="font-size: x-small; width: 100%;"> <tr> <td>Fix</td> <td>blackout</td> <td>1fps</td> <td>2fps</td> <td>3fps</td> <td>4fps</td> <td>5fps</td> <td>6fps</td> <td>7fps</td> <td>8fps</td> <td>9fps</td> <td>10fps</td> <td>12fps</td> <td>14fps</td> <td>16fps</td> <td>fix</td> </tr> <tr> <td>0..15</td> <td>16..31</td> <td>32..47</td> <td>48..63</td> <td>64..79</td> <td>80..95</td> <td>96..111</td> <td>112..127</td> <td>128..143</td> <td>144..159</td> <td>160..175</td> <td>176..191</td> <td>192..207</td> <td>208..223</td> <td>224..239</td> <td>240..254</td> </tr> </table>	Fix	blackout	1fps	2fps	3fps	4fps	5fps	6fps	7fps	8fps	9fps	10fps	12fps	14fps	16fps	fix	0..15	16..31	32..47	48..63	64..79	80..95	96..111	112..127	128..143	144..159	160..175	176..191	192..207	208..223	224..239	240..254
Fix	blackout	1fps	2fps	3fps	4fps	5fps	6fps	7fps	8fps	9fps	10fps	12fps	14fps	16fps	fix																			
0..15	16..31	32..47	48..63	64..79	80..95	96..111	112..127	128..143	144..159	160..175	176..191	192..207	208..223	224..239	240..254																			

➤ **RDM COMMANDS**

<i>REQUIRED PARAMETERS</i>	
DISC_UNIQUE_BRANCH	✓
DISC_UN_MUTE	✓
SUPPORTED_PARAMETERS	✓
PARAMETERS_DESCRIPTION	✓
DEVICE_INFO	✓
SOFTWARE_VERSION_LABEL	✓
DMX_START_ADDRESS	✓
IDENTIFY_DEVICE	✓

<i>SUPPORTED PARAMETERS</i>	
PRODUCT_DETAIL_ID_LIST	✓
DEVICE_MODEL_DESCRIPTION	✓
MANUFACTURER_LABEL	✓
DEVIDE_LABEL	✓
BOOT_SOFTWARE_VERSION_ID	✓
BOOT_SOFTWARE_VERSION_LABEL	✓
DMX_PERSONALITY	✓
DMX_PERSONALITY_DESCRIPTION	✓
SLOT_INFO	✓
SLOT_DESCRIPTION	✓
DEFAULT_SLOT_VALUE	✓

➤ DMX MASTER / SLAVE

Example to Master / Slave connection

More DLD1248-4CH-DMX device can be connected following a master/slave configuration. Master and Slave must be the same DIP-SWITCH configuration. To select the desired local command, DIP-SWITCH need to be set as explained in **Setup DMX MASTER/SLAVE** on page 21 and 22.

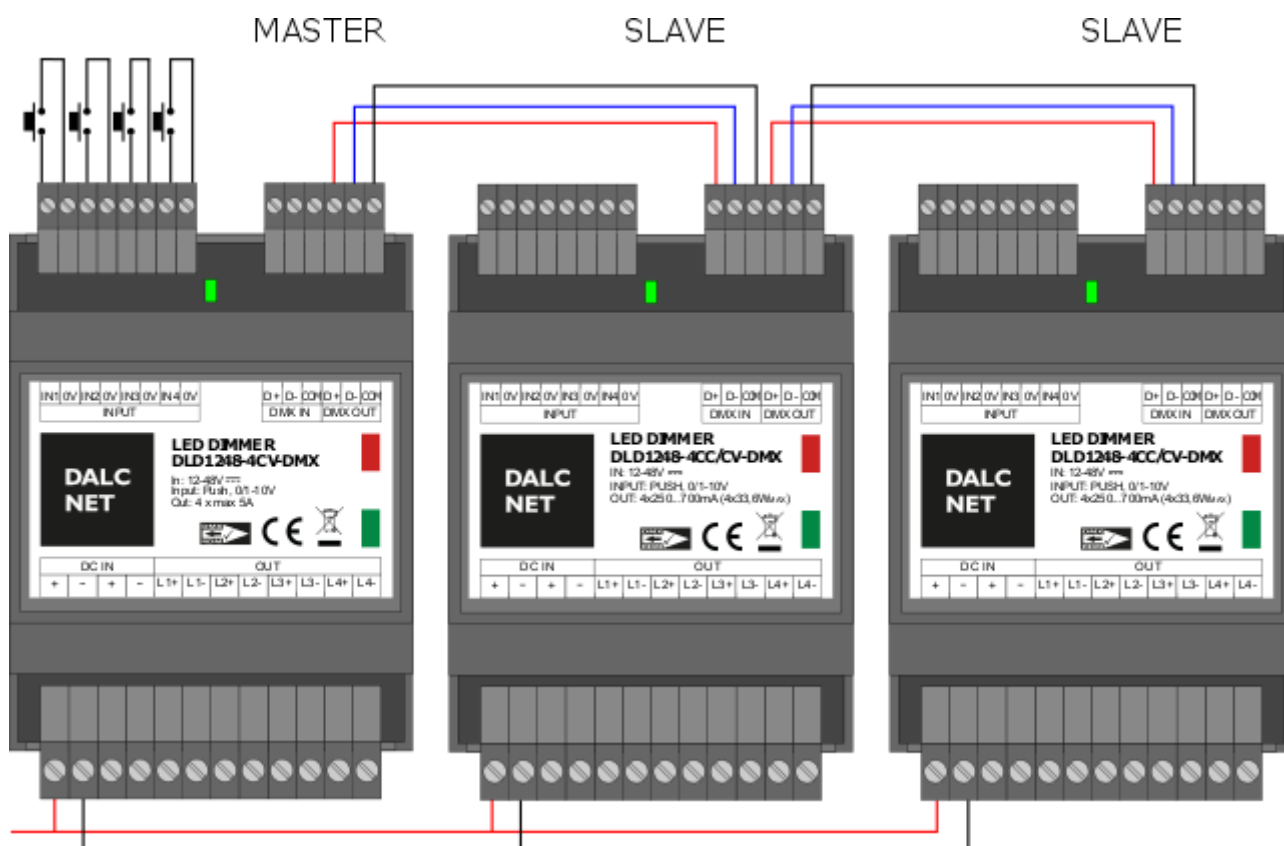

➤ **SETUP DMX Master/Slave**

MASTER:

Note: Master and Slave must have set the same map, (switches from 4 to 6).

Default Master:



Master with FADE UP / FADE DOWN:

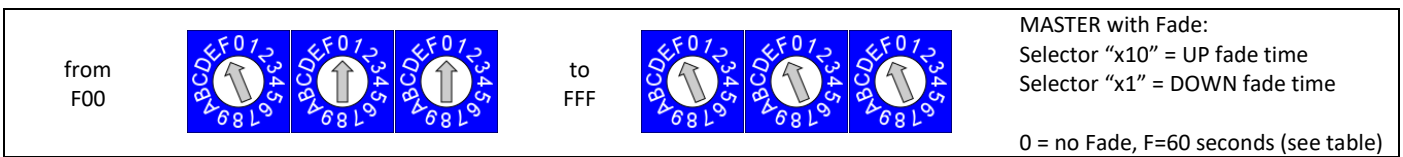

Fades times:

0	1	2	3	4	5	6	7	8	9	A	B	C	D	E	F
NO fade	0.5s	1s	2s	3s	4s	5s	6s	7s	8s	9s	10s	15s	20s	30s	60s

Examples:

Turn on/off without fade (no Fade UP/DOWN): F00

Turn on without fade (no fade UP) and turn off fade of 5 seconds (fade DOWN): F06

Turn on fade of 1 seconds (fade UP) and turn off fade of 10 seconds (fade DOWN): F2B

Notes:

This function is available on maps: "Dimmer", "Dim to Warm", "Tunable White", "Smart Colors"

The Slaves follow master fade ramps.



SLAVE:

Note: Master and Slave must have set the same map (switches from 4 to 6).

Default Slave:

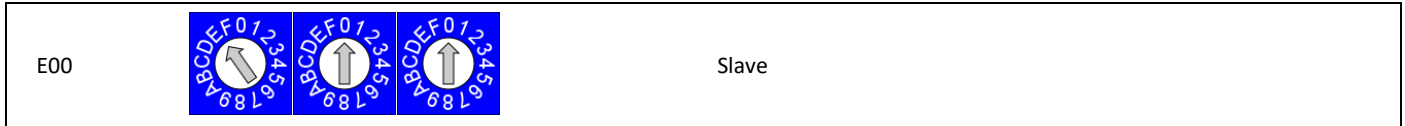

Slave: **Color Wave effect** (only in map “Smart HSV”):



Easy creates a “color wave” effect, adding a delay from the master phase synchronism.
The delay is selected on each slave in step of 15°, from 0° (E00) to 345° (E23)

from E00		to E23		Slave, Color Wave effect: 00 = sync with master (no wave) 01 = 15° phase ... 08 = 120° phase ... 16 = 240° phase ... 23 = 345° phase
-------------	--	-----------	--	--

Phase delays:

E00	E01	E02	E03	E04	E05	E06	E07	E08	E09	E10	E11
0°	15°	30°	45°	60°	75°	90°	105°	120°	135°	150°	165°
E12	E13	E14	E15	E16	E17	E18	E19	E20	E21	E22	E23
180°	195°	210°	225°	240°	255°	270°	285°	300°	315°	330°	345°

Examples:

E00 0° Sync with master	E04 60° phase delay	E08 120° phase delay R→B, G→R, B→G	E12 180° phase delay Complementary color	E16 240° phase delay R→G, G→B, B→R	E20 300° phase delay

➤ MODBUS SETUP

In **MODBUS SETUP** in the “slave” condition the outputs LEDs are managed by an external MODBUS RTU master controller (RS-485)

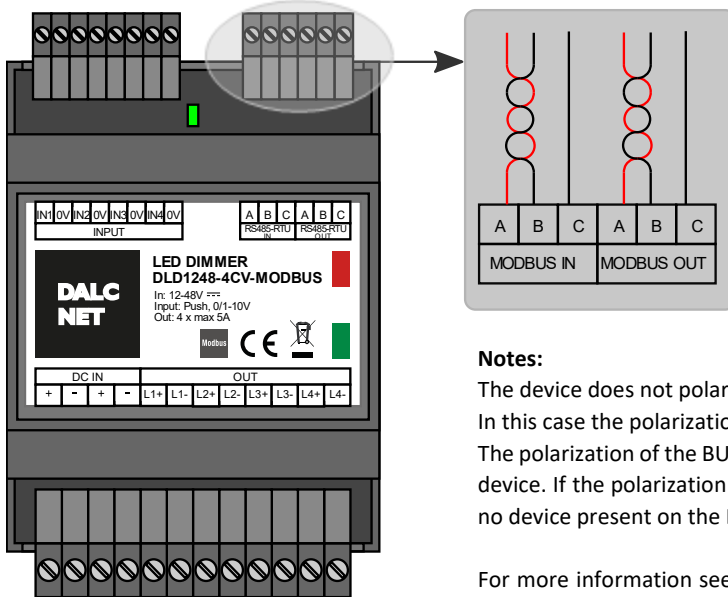

FEATURES

- BUS MODBUS RTU SLAVE on RS485

MODBUS REFERENCE STANDARDS

- MODBUS APPLICATION PROTOCOL SPECIFICATION V1.1b

Notes:

The device does not polarize and there isn't implemented the ability to polarize the BUS. In this case the polarization of the BUS must be implemented externally.

The polarization of the BUS can be carried out by the Master Modbus or on the terminals of the device. If the polarization of the BUS is carried out by Master or on the terminal of the device, no device present on the BUS must implement any polarization.

For more information see the MODBUS specification **“MODBUS over serial line specification and implementation guide V1.02”**.



ONBOARD LED:



- In the case of bus error, the led blinks fast (2 pulsed per second).
- In the case of no bus detected, led blinks slow (1 pulse per second).
- In the case of data link active, the led stands on.

RELATION WITH LOCAL COMMANDS

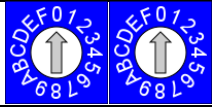
- **LOCAL COMMAND SET UP AS N.O. PUSH BUTTON:**
The local command is always active even in presence of the bus. If you use the local command, the available variables are updated in read/write to the bus. Instead if you use the bus, the status of local command is update.
This setting allows you to control the output status whether local command or bus at the same time. The local command has always priority to bus command. The status of the device is visible from bus and can be viewed by a supervision system.
- **LOCAL COMMAND SET UP AS 0..10V, 1..10V OR POTENTIOMETER**
At power-up, in case of absence of connection to the BUS, local control is active.
When the BUS is detected, the control passes to the BUS. It remains to the BUS until there is signal.
In absence of signal, the control passes immediately to the local command.

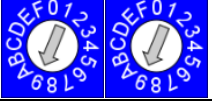
ADDRESSING BY SELECTORS

Selectors x10, x1 (middle and right)			
Modbus	00 (Default)		Default modbus ID (1)
	from 01		to 99 

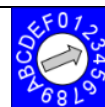
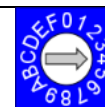
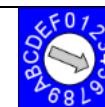
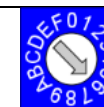
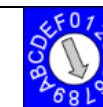
Selector x100 (left)								
Modbus								
	0 115200 baud 8N1	1 115200 baud 8E1	2 38400 baud 8N1	3 38400 baud 8E1	4 19200 baud 8N1	5 19200 baud 8E1	6 9600 baud 8N1	7 9600 baud 8E1



➤ **CHANNELS MAP – MODBUS**

○ Load Type: White – up to 4 loads

Var	Function	Map: Dimmer
0	Dimmer 1	Dimmer (Brightness Value) 0 .. 255
1	Dimmer 2	Dimmer (Brightness Value) 0 .. 255
2	Dimmer 3	Dimmer (Brightness Value) 0 .. 255
3	Dimmer 4	Dimmer (Brightness Value) 0 .. 255

○ Load Type: White – Parallel outs (Macro dimmer)

Var	Function	Map: Dimmer
0	Dimmer	Dimmer (Brightness Value) 0 .. 255

●● Load Type: Tunable White – up to 2 loads

Var	Function	Map: Dimmer
0	Dimmer 1	Dimmer (Brightness Value) 0 .. 255
1	Dimmer 2	Dimmer (Brightness Value) 0 .. 255

Var	Function	Map: Dim to Warm
0	Dimmer 1	Dimmer (Brightness Value) 0 .. 255
1	Dimmer 2	Dimmer (Brightness Value) 0 .. 255

Var	Function	Map: Tunable white
0	Dimmer 1	Dimmer (Brightness Value) 0 .. 255
1	Color Correction 1	Color correction temperature 0 .. 255
2	Dimmer 2	Dimmer (Brightness Value) 0 .. 255
3	Color Correction 2	Color correction temperature 0 .. 255

●● Load Type: Tunable White – Parallel outs

Var	Function	Map: Dimmer
0	Dimmer	Dimmer (Brightness Value) 0 .. 255

Var	Function	Map: Dim to Warm
0	Dimmer	Dimmer (Brightness Value) 0 .. 255

Var	Function	Map: Tunable white
0	Dimmer	Dimmer (Brightness Value) 0 .. 255
1	Color Correction	Color correction temperature 0 .. 255

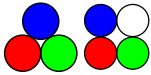

Load Type: RGB & RGBW

Var	Function	Map: Dimmer
0	Master Dimmer	Dimmer (Brightness Value) 0 .. 255

Var	Function	Map: Dim to Warm
0	Master Dimmer	Dimmer (Brightness Value) 0 .. 255

Var	Function	Map: Tunable white
0	Master Dimmer	Dimmer (Brightness Value) 0 .. 255
1	Color Correction	Color temperature correction 0 .. 255

Var	Function	Smart HSV																																
0	Master Dimmer	Dimmer (Brightness Value) 0 .. 255																																
1	Color Correction	Color temperature correction 0 .. 255																																
2	Hue	Hue 0 .. 255																																
3	Hue Rotation (rainbow) Time	<table border="1" style="font-size: small;"> <tr> <td>Hue Fine</td> <td>Hold</td> <td>30min</td> <td>15min</td> <td>6min</td> <td>3min</td> <td>1min</td> <td>30s</td> <td>15s</td> <td>6s</td> <td>3s</td> </tr> <tr> <td>0 ... 15</td> <td>16 ... 25</td> <td>26 .. 51</td> <td>52 .. 76</td> <td>77 .. 102</td> <td>103..127</td> <td>128..153</td> <td>154..179</td> <td>180..204</td> <td>205..230</td> <td>231..254</td> </tr> </table>	Hue Fine	Hold	30min	15min	6min	3min	1min	30s	15s	6s	3s	0 ... 15	16 ... 25	26 .. 51	52 .. 76	77 .. 102	103..127	128..153	154..179	180..204	205..230	231..254										
Hue Fine	Hold	30min	15min	6min	3min	1min	30s	15s	6s	3s																								
0 ... 15	16 ... 25	26 .. 51	52 .. 76	77 .. 102	103..127	128..153	154..179	180..204	205..230	231..254																								
4	Saturation	Saturation 0 .. 255																																
5	Strobo Rate	<table border="1" style="font-size: small;"> <tr> <td>fix</td> <td>blackout</td> <td>1fps</td> <td>2fps</td> <td>3fps</td> <td>4fps</td> <td>5fps</td> <td>6fps</td> <td>7fps</td> <td>8fps</td> <td>9fps</td> <td>10fps</td> <td>12fps</td> <td>14fps</td> <td>16fps</td> <td>fix</td> </tr> <tr> <td>0..15</td> <td>16..31</td> <td>32..47</td> <td>48..63</td> <td>64..79</td> <td>80..95</td> <td>96..111</td> <td>112..127</td> <td>128..143</td> <td>144..159</td> <td>160..175</td> <td>176..191</td> <td>192..207</td> <td>208..223</td> <td>224..239</td> <td>240..254</td> </tr> </table>	fix	blackout	1fps	2fps	3fps	4fps	5fps	6fps	7fps	8fps	9fps	10fps	12fps	14fps	16fps	fix	0..15	16..31	32..47	48..63	64..79	80..95	96..111	112..127	128..143	144..159	160..175	176..191	192..207	208..223	224..239	240..254
fix	blackout	1fps	2fps	3fps	4fps	5fps	6fps	7fps	8fps	9fps	10fps	12fps	14fps	16fps	fix																			
0..15	16..31	32..47	48..63	64..79	80..95	96..111	112..127	128..143	144..159	160..175	176..191	192..207	208..223	224..239	240..254																			

Var	Function	Map: RGB
0	R	R 0 .. 255
1	G	G 0 .. 255
2	B	B 0 .. 255

Var	Function	Map: RGBW
0	R	R 0 .. 255
1	G	G 0 .. 255
2	B	B 0 .. 255
3	W	W 0 .. 255

Var	Function	Map: MRGB+																
0	Master Dimmer	Master Dimmer (Brightness Value) 0 .. 255																
1	R	R 0 .. 255																
2	G	G 0 .. 255																
3	B	B 0 .. 255																
4	Strobo Rate	<table border="1" style="font-size: small;"> <tr> <td>Fix</td> <td>blackout</td> <td>1fps</td> <td>2fps</td> <td>3fps</td> <td>4fps</td> <td>5fps</td> <td>6fps</td> <td>7fps</td> <td>8fps</td> <td>9fps</td> <td>10fps</td> <td>12fps</td> <td>14fps</td> <td>16fps</td> <td>fix</td> </tr> </table>	Fix	blackout	1fps	2fps	3fps	4fps	5fps	6fps	7fps	8fps	9fps	10fps	12fps	14fps	16fps	fix
Fix	blackout	1fps	2fps	3fps	4fps	5fps	6fps	7fps	8fps	9fps	10fps	12fps	14fps	16fps	fix			

Var	Function	Map: MRGBW+																
0	Master Dimmer	Master Dimmer (Brightness Value) 0 .. 255																
1	R	R 0 .. 255																
2	G	G 0 .. 255																
3	B	B 0 .. 255																
4	W	W 0 .. 255																
5	Strobo Rate	<table border="1" style="font-size: small;"> <tr> <td>Fix</td> <td>blackout</td> <td>1fps</td> <td>2fps</td> <td>3fps</td> <td>4fps</td> <td>5fps</td> <td>6fps</td> <td>7fps</td> <td>8fps</td> <td>9fps</td> <td>10fps</td> <td>12fps</td> <td>14fps</td> <td>16fps</td> <td>fix</td> </tr> </table>	Fix	blackout	1fps	2fps	3fps	4fps	5fps	6fps	7fps	8fps	9fps	10fps	12fps	14fps	16fps	fix
Fix	blackout	1fps	2fps	3fps	4fps	5fps	6fps	7fps	8fps	9fps	10fps	12fps	14fps	16fps	fix			

➤ **SUPPORTED FUNCTIONS FOR READING AND WRITING – MODBUS RTU**

Function code		
0x01	Read Coils	×
0x02	Read Discrete Inputs	×
0x03	Read Holding Registers	✓
0x04	Read Input Register	×
0x05	Write Single Coil	×
0x06	Write Single Register	✓
0x07	Read Exception Status	×
0x08	Diagnostic	×
0x0B	Get Co Event Counter	×
0x0C	Get Com Event Log	×
0x0F	Write Multiple Coils	×
0x10	Write Multiple Registers	✓
0x11	Report Server ID	×
0x14	Read File Record	×
0x15	Write File Record	×
0x16	Mask Write Register	×
0x17	Read/Write Multiple Registers	×
0x18	Read FIFO queue	×
0x2B	Read Device Identification	×