

RK4-1, RK4-2, RK4-4, RK4-U

4-Button RF Remote Controller

RF DIM/CCT/RGB/RGBW



RK4-1
1 Zone Dimming



RK4-2
1 Zone CCT

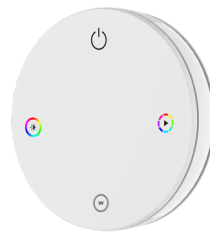

RK4-4
1 Zone RGB/RGBW



RK4-U
4 Scenes / 4 Zones

CE RoHS RED

- Apply to single color or dual color(warm white + cool white) or RGB/RGBW LED controller.
- Each remote can match one or more receiver.
- CR2032 battery powered.
- Operate with LED indicator light.
- Magnet on the back which can be stuck on back holder.

Technical Parameters

Input and Output		Safety and EMC		Environment		
Output signal	RF(2.4GHz)	EMC standard	ETSI EN 301 489-1 V2.2.3	Operation temperature	Ta: -30 °C ~ +55 °C	
Working voltage	3VDC(CR2032)		ETSI EN 301 489-17 V3.2.4			
Working current	<5mA	Safety standard	EN 61347-1:2015+A1:2021	Package	Size	L80 x W80 x H30mm
Standby current	<5µA		EN 61347-2-13:2014+A1:2017			
Standby time	2 year	Radio Equipment	ETSI EN 300 328 V2.2.2	Warranty	Warranty	5 years
Remote distance	30m(Barrier-free space)	Certification	CE RED			

Mechanical Structures and Installations

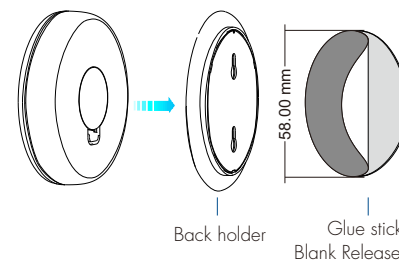
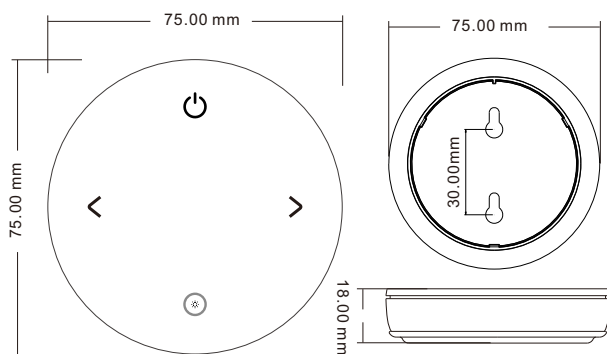

Note: If the LED indicator is not on when press button, it is due to dead battery or bad contact caused by multiple plugging, please replace the battery, or raise the battery shrapnel with a screwdriver

To fix the remote' back holder, two options are offered for selection:
Option 1: fix the remote' back holder on the wall with two screws.
Option 2: adhere the remote' back holder to the wall with glue sticker.

Match Remote Control (two match ways)

End user can choose the suitable match/delete ways. Two options are offered for selection:

Use the controller's Match key

Match:
Short press match key, immediately press on/off key on the remote.
The LED indicator fast flash a few times means match is successful.

Delete:
Press and hold match key for 5s to delete all match,
The LED indicator fast flash a few times means all matched remotes were deleted.

Use Power Restart

Match:
Switch off the power, then switch on power, repeat again.
Immediately short press on/off key 3 times on the remote.
The light blinks 3 times means match is successful.

Delete:
Switch off the power, then switch on power, repeat again.
Immediately short press on/off key 5 times on the remote.
The light blinks 5 times means all matched remotes were deleted.

Button function



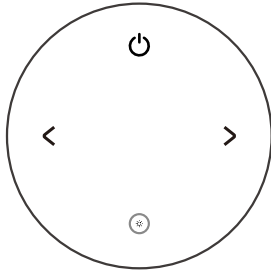

● RK4-1 1 zone Dimming remote

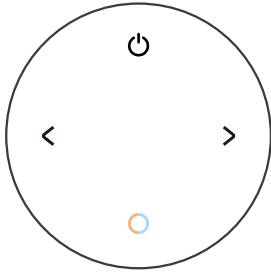

-  : Turn on/off light.
-  : Brightness decrease, short press 10 levels, long press brightness decreases continuously.
-  : Brightness increase, short press 10 levels, long press brightness increases continuously.
-  : Switch between 10% and 100% brightness.





● RK4-2 1 zone CCT remote

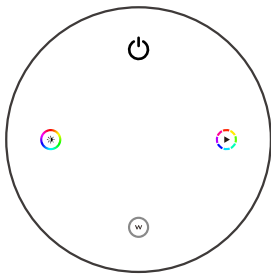

-  : Turn on/off light.
-  : Brightness decrease, short press 10 levels, long press brightness decreases continuously.
-  : Brightness increase, short press 10 levels, long press brightness increases continuously.
-  : Short press to switch five color temperatures in sequence; long press to increase or decrease the color temperature continuously.







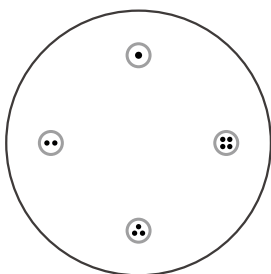

● RK4-4 1 zone RGB/RGBW remote



-  : Turn on/off light.
-  : Short press to sequentially switch 24 static colors; long press to adjust brightness.
-  : Short press sequence to toggle dynamic mode; long press for 2 seconds to adjust speed.
-  : Short press for white light; long press to adjust white light brightness.

● RK4-U 4 scenes/4 zones remote



-  : Scene 1 / Zone 1
-  : Scene 2 / Zone 2
-  : Scene 3 / Zone 3
-  : Scene 4 / Zone 4
-  +  : Press and hold for 5 seconds to set to four scenes, the indicator blinks 2 times.
-  +  : Press and hold for 5 seconds to set to four zones, the indicator blinks 4 times.

Four scenes: short press to call up the scene, short press again to turn off the scene light.

Four zones: short press to turn on/off the zone light, long press to adjust the brightness of the zone light. The factory default is four zones function.

Safety information

1. Read all instructions carefully before you begin this installation.
2. When installing battery, pay attention to the battery positive and negative polarity.
A long time without the remote control, remove the battery.
When remote distance becomes smaller and insensitive, replace the battery.
3. If no response from the receiver, please re-match the remote.
4. Gently handle remote, beware of falling.
5. For indoor and dry location use only.